

Hrady doby lucemburské a poděbradské



Jiří Jánský 2009

Jan Lucemburský

1310 - 1346

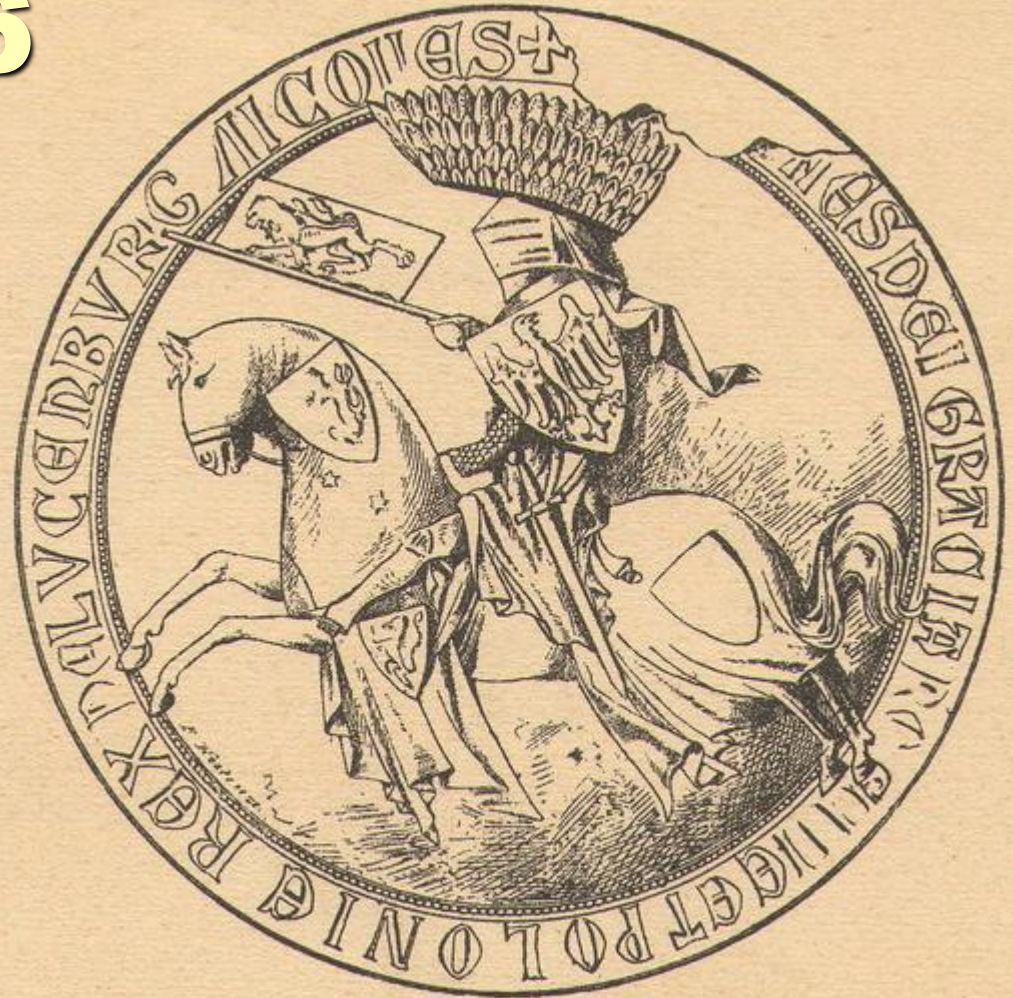

Dům U kamenného zvonu



Eliška Přemyslovna
(Svatovítské dolní inforium)



Hrad Vianden v Lucembursku údajné rodiště Jana Lucemburského





Střekov



Zbořený Kostelec

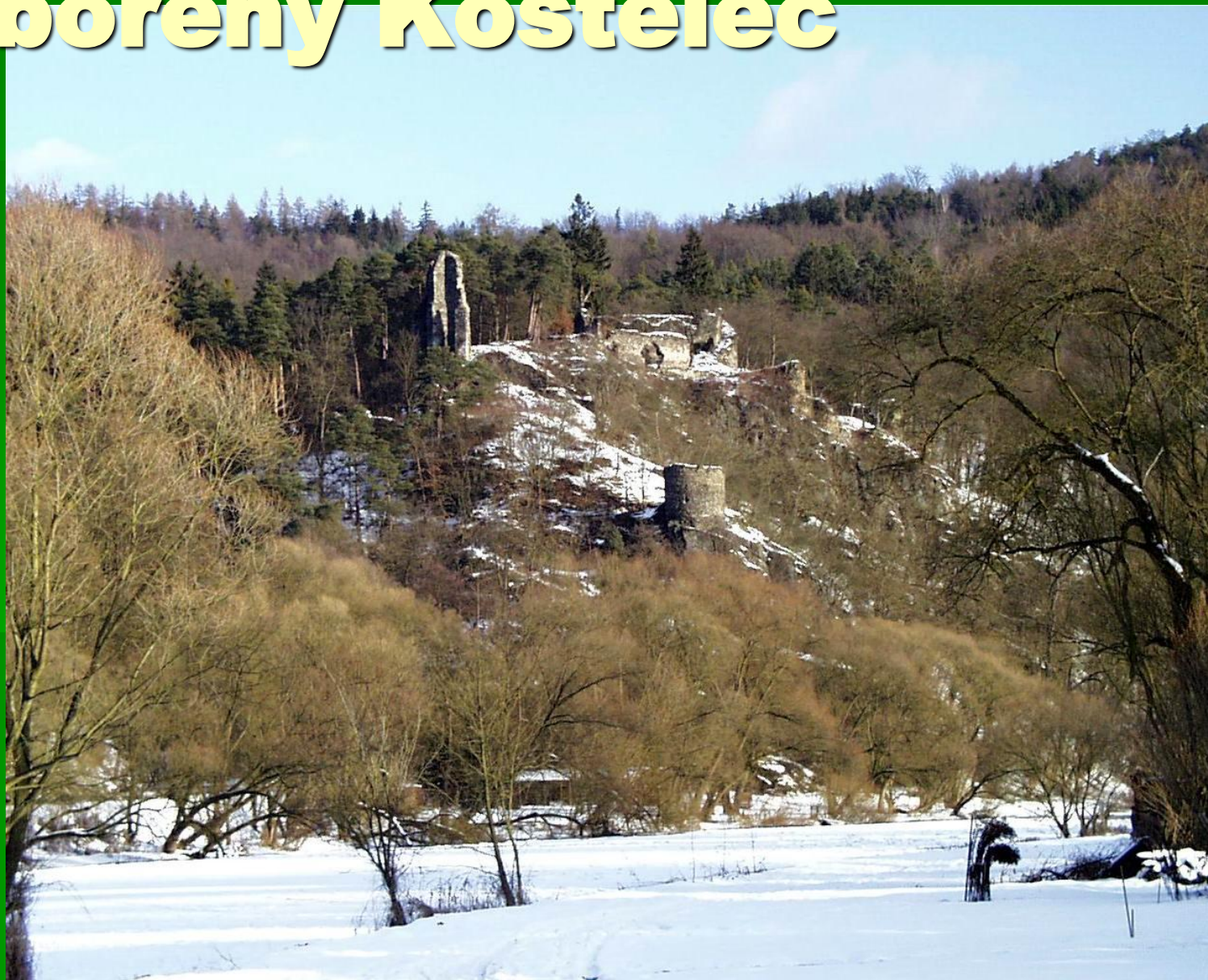

Zbořený Kostelec

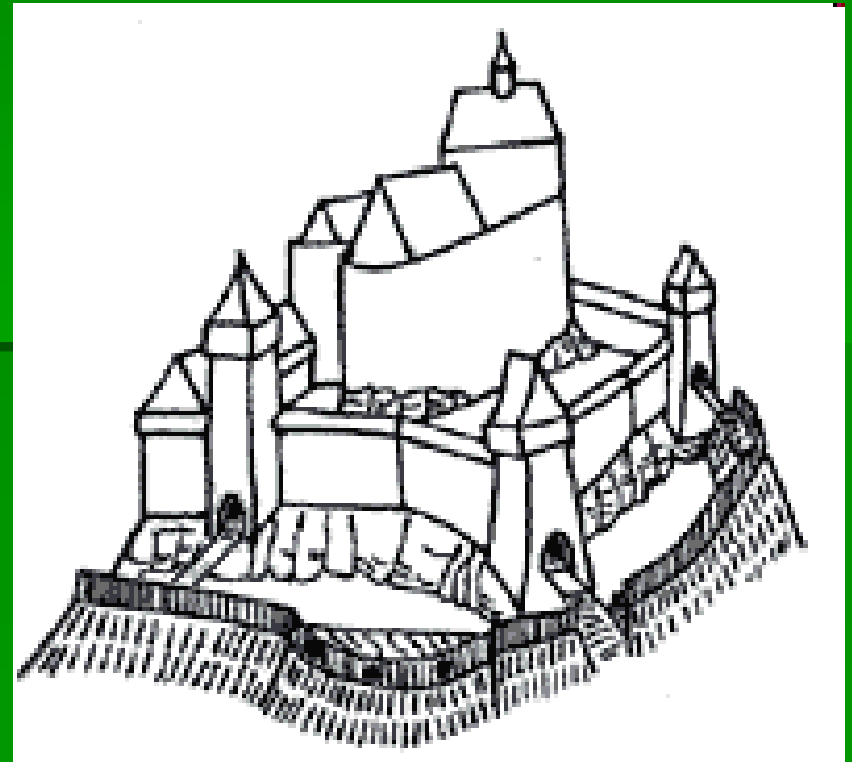
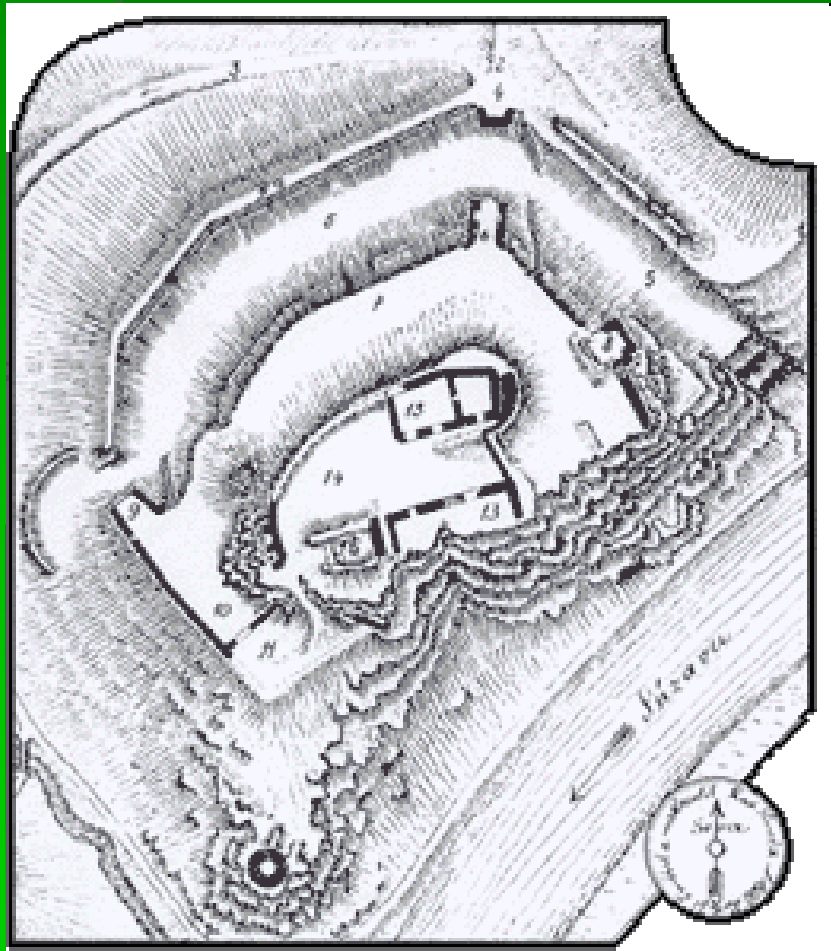

Preitenstein Nečtiny

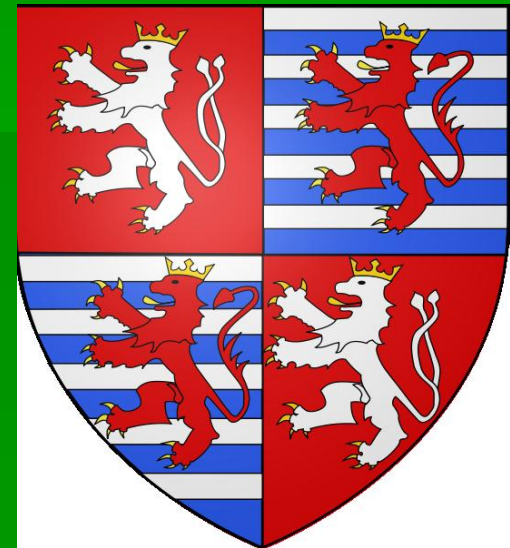
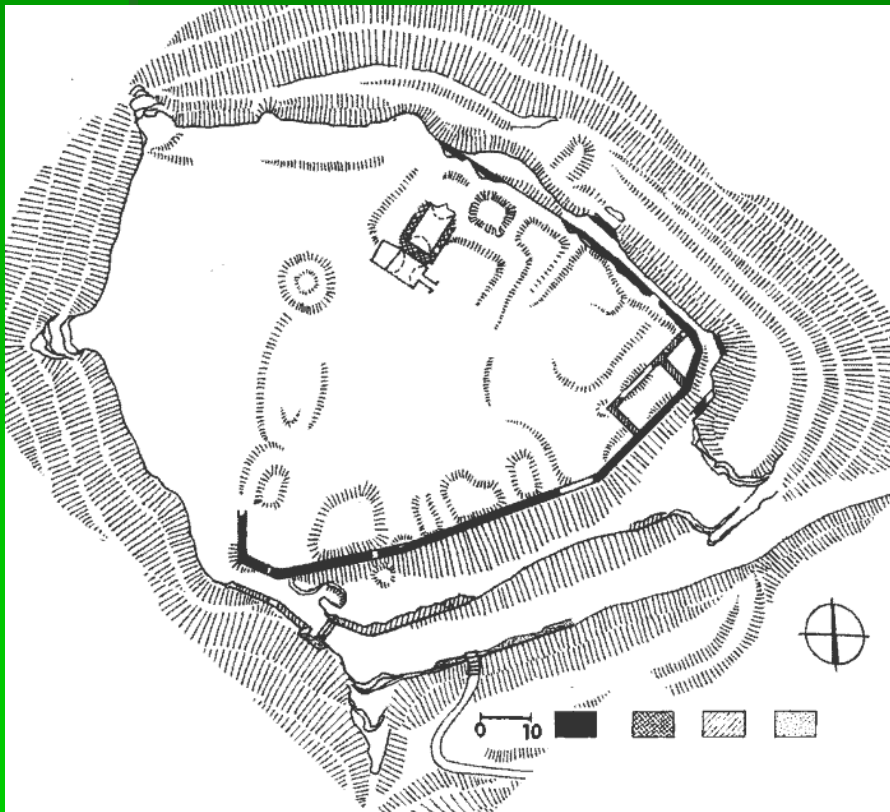

Jan IV. z Dražic 1301 – 1343 biskup pražský



- Vedle svých zásluh o český překlad Bible byl Jan z Dražic také velkým stavebníkem: dal přestavět kostel svatého Jiljí na Starém Městě, biskupský dvůr na Malé straně, biskupský hrad a klášter v Roudnici. Založil město Nové Benátky (dnes Benátky nad Jizerou), dal postavit roudnický most, hrad a kostel svaté Ludmily v Dražicích a další.



Jan IV. z Dražic

11 let v Avignonu

- Mistr
- Vilém z Avignonu



Devotio moderna bosí augustiniáni



Třetí kamenný most v Čechách

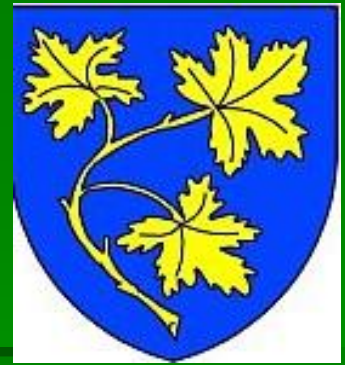

Roudnice nad Labem klášter a hrad





Dražice

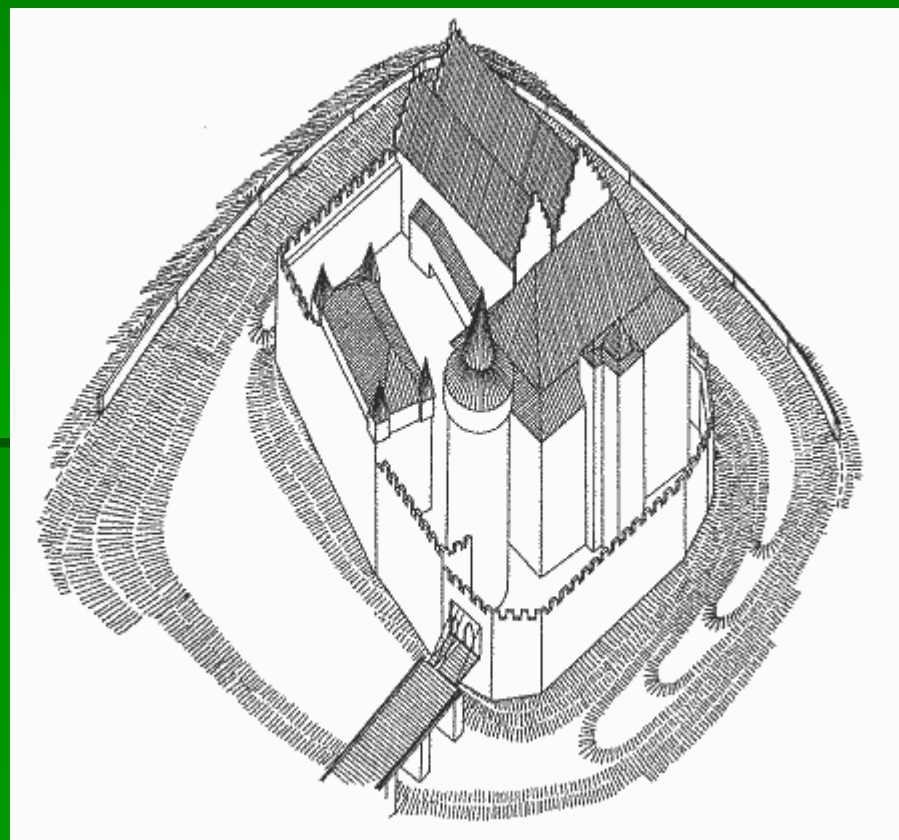

Tvrz v Litovicích

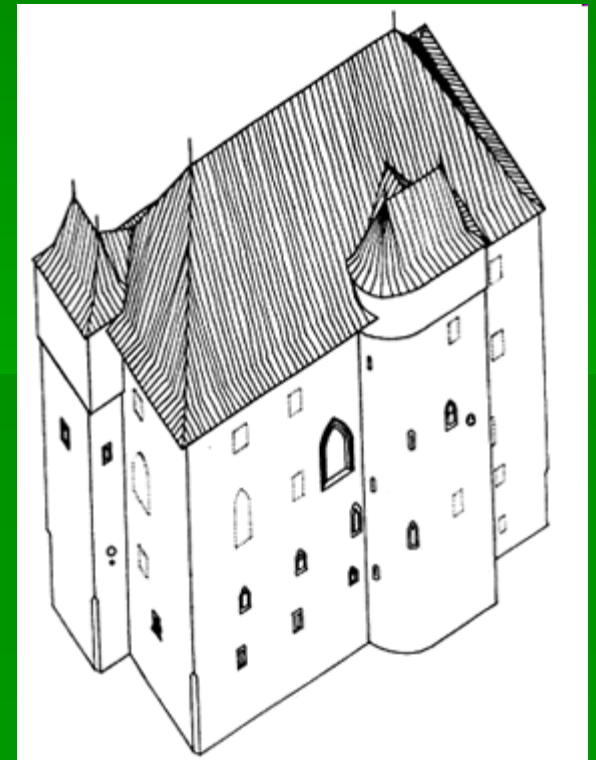
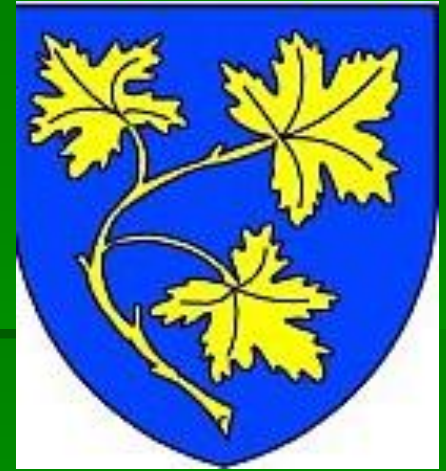

Kresčak

26. srpna 1346





Podvojn e dispozice doby Karla IV.

1347 - 1378

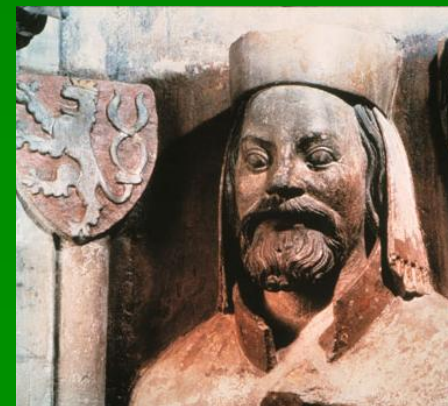



Montecarlo v Toskáně 1333



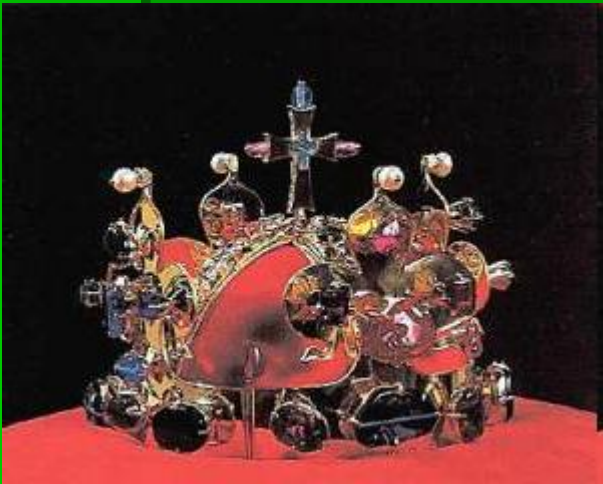

Starý královský palác a kaple Všech svatých

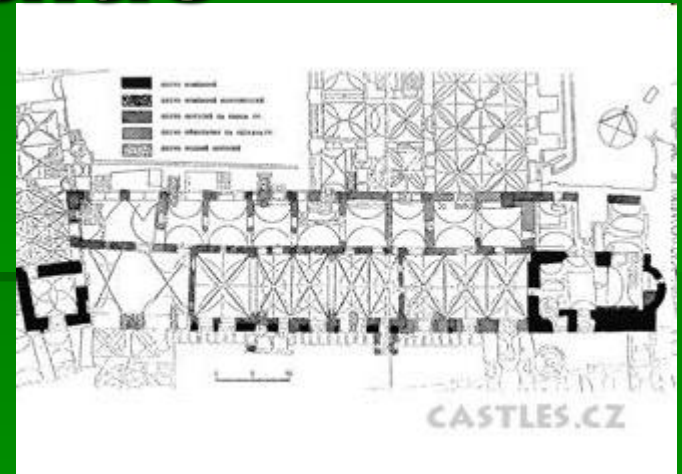

Karlovy arkády



Hladová zed' – opevnění Pražského Hradu a Malé Strany



Nové Město

- P.M. Karlov, klášter
- P.M. Na trávníčku klášter
- S. Apolináře, kapitula
- S. Kateřina, klášter
- Emauzy, klášter
- Božího těla
- P. M. Sněžná
- S. Michal Na Slupi

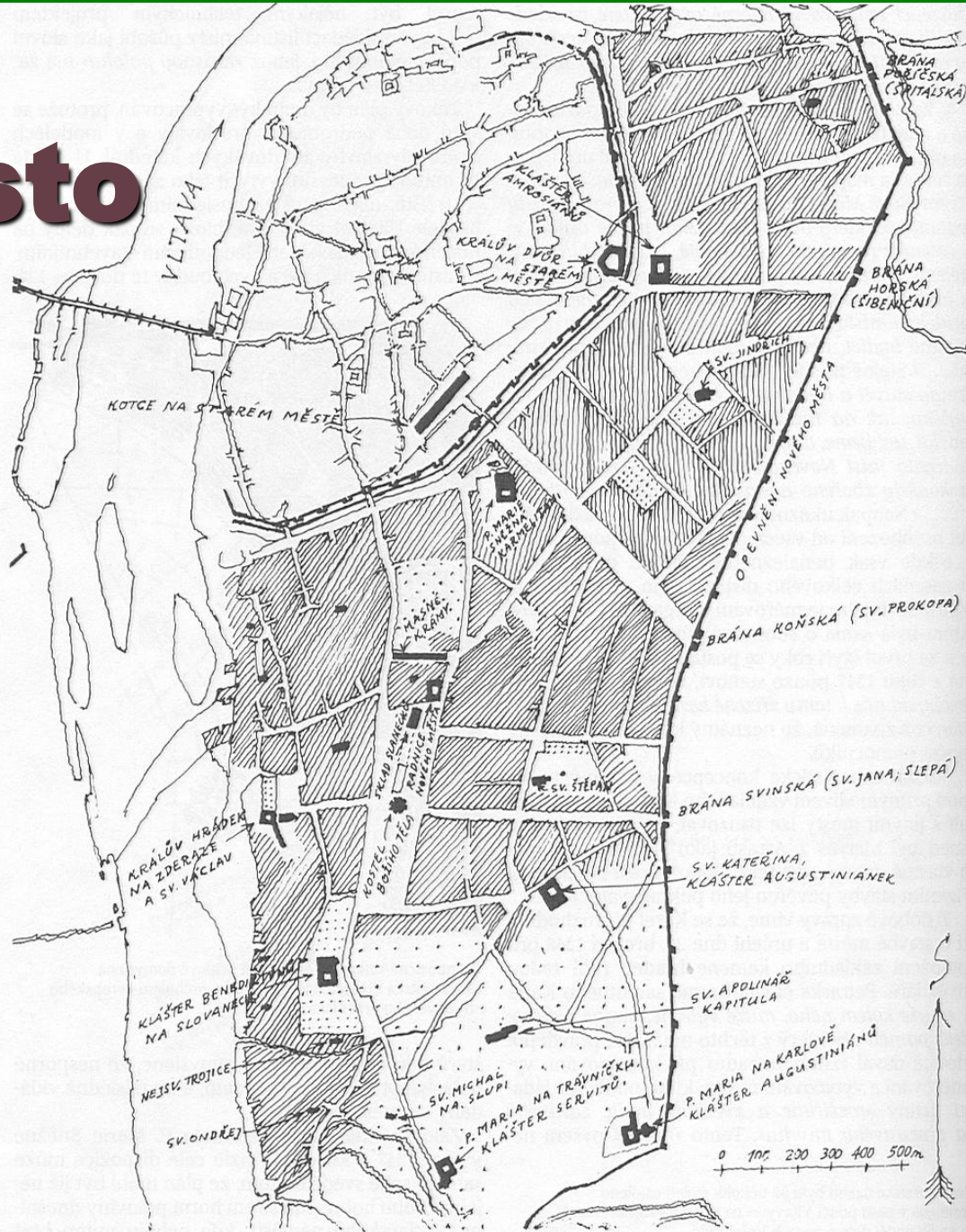

Karlsberg - Kašperk

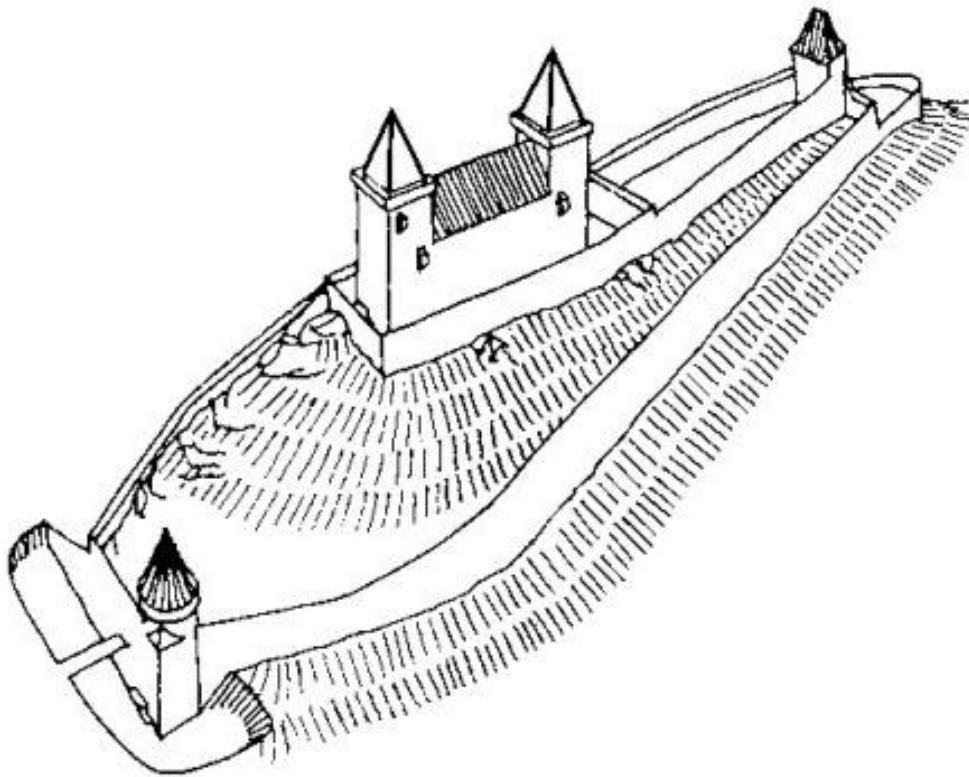

Hrad Kašperk - hmotová rekonstrukce (dle T. Durdíka)

- Stavbou v pořadí čtvrtého hradu postaveného Otcem vlasti, byl pověřen Vít, zvaný Hedvábný, v rozmezí let 1356 až 1361. Vlastním realizátorem stavby pod organizačním dohledem Vítovým, měl být údajně mladší bratr Petra Parlěře, slavného architekta svatovítské katedrály, Michal Parlěř.

Kašperk 886 m nad mořem



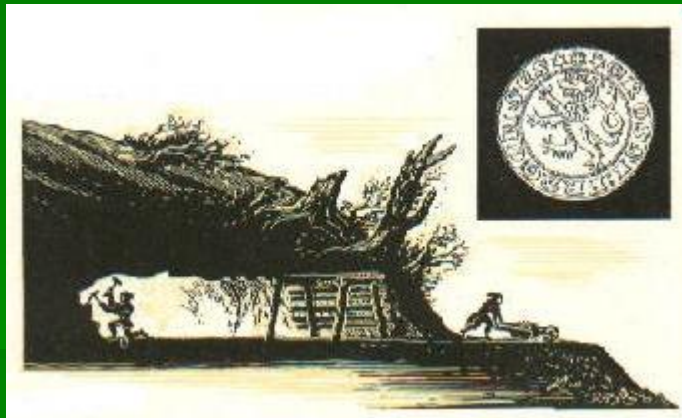

Kašperskohorský zlatonosný revír

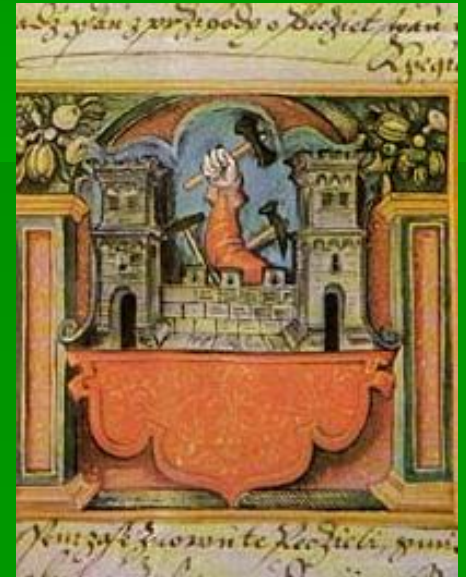

Zlatá stezka



Schilhenstein – Pustý Hrádek

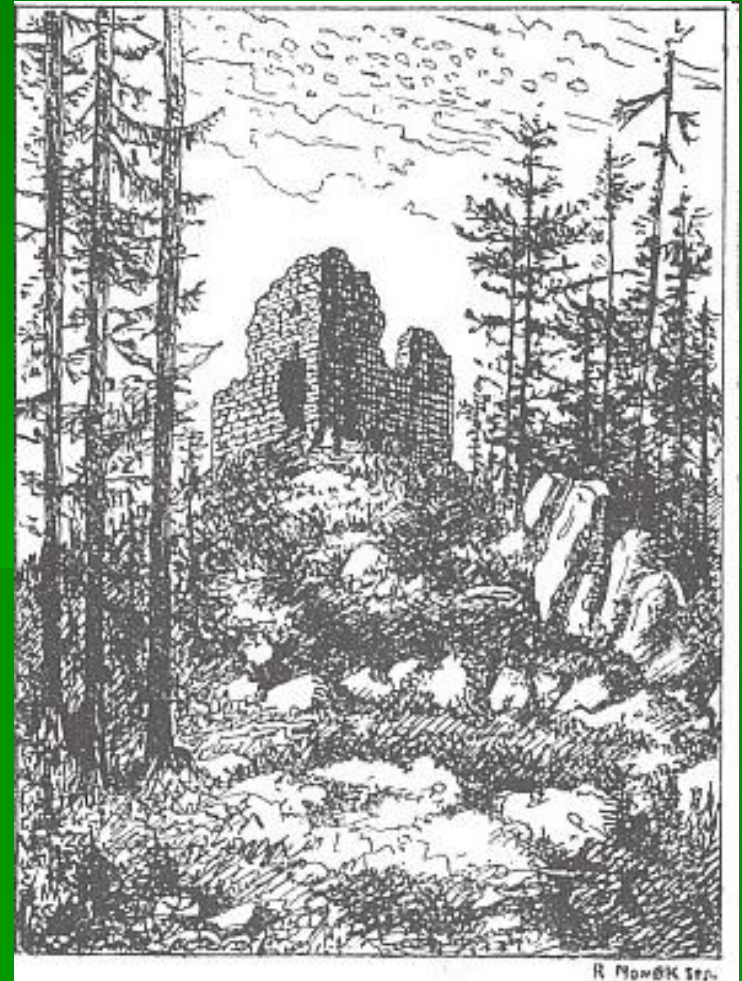

Radyně - Karlskrone



Hůrka u Starého Plzně



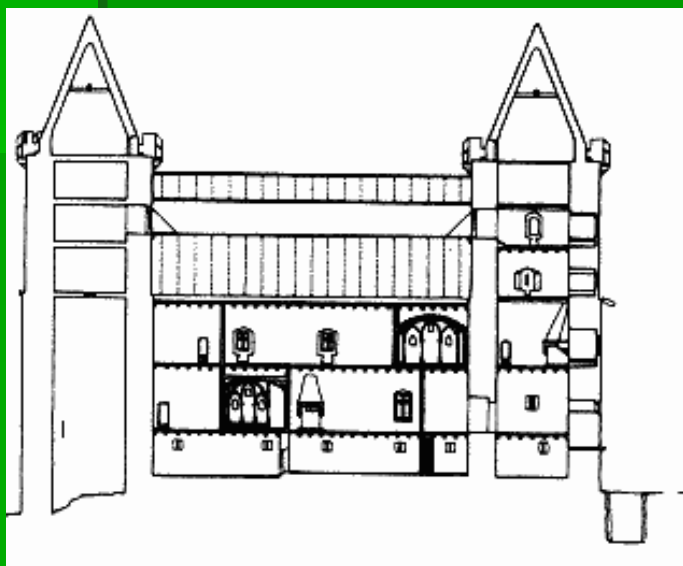
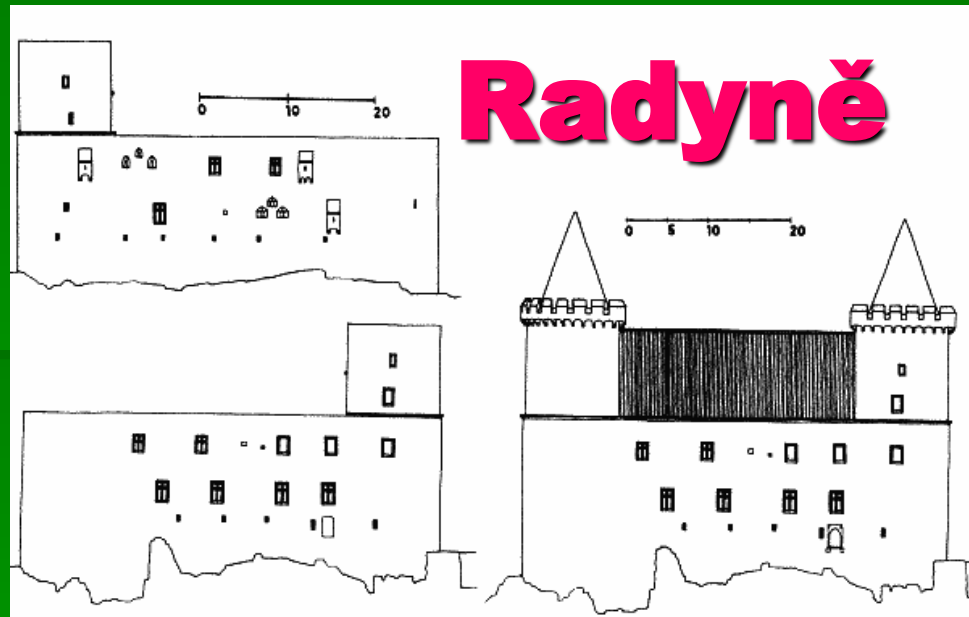
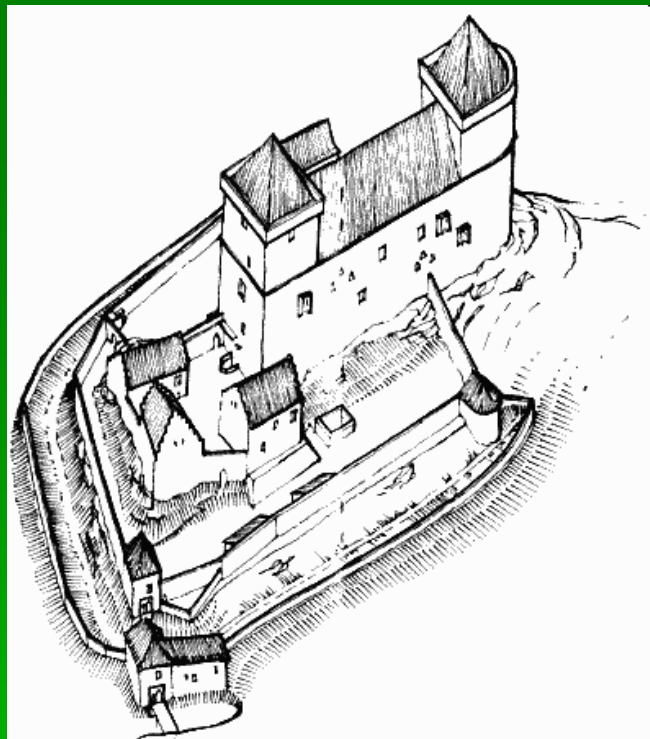

Vyšehrad

„Libušina lázeň“





Trosky



Léna České koruny a Goldene Strasse





*Pflug von Rabenstein
1409–1496*

Neustadt a. d. Waldnaab

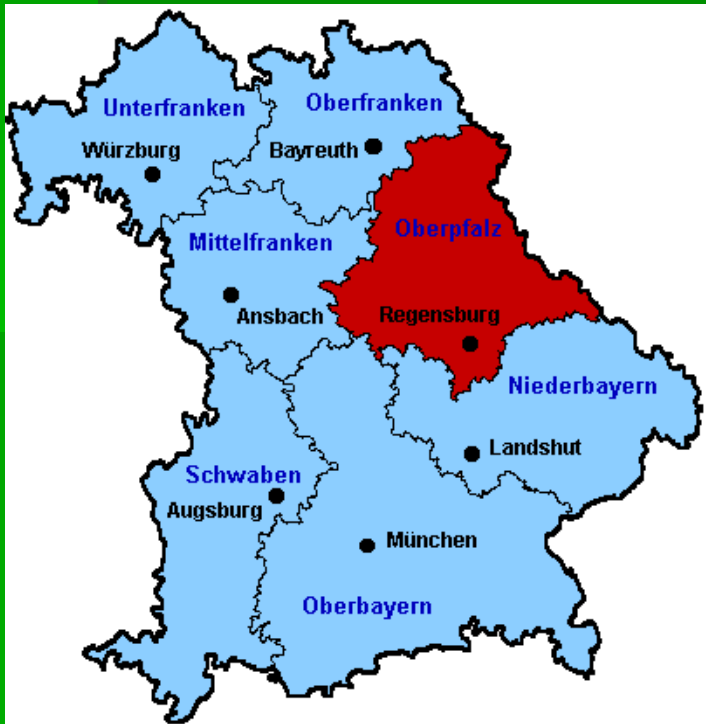

Norimberk oblíbené město Karla IV.



Hrad Lauf u Norimberka „Wenzelsburg“



Lauf – erbovní galerie





Erby Vítkovců, Šternberků, Ronovců, Vartenberků aj.



Nejstarší znak Prahy



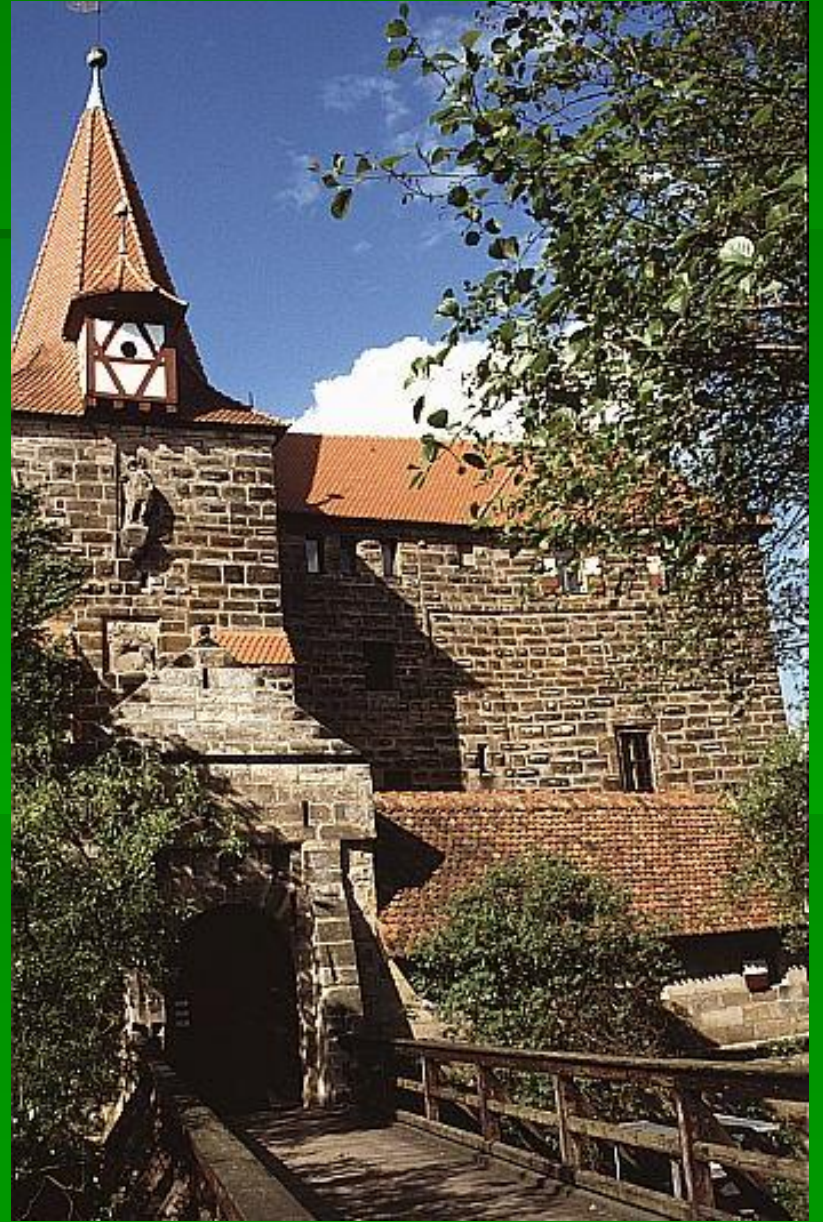

Znaky erbovního sálu

Duces Ducēs
Opohensis. Slesie .



Dux Marchio
Swidmencens. Moravie .



drabkow. ojezprece. kassylow turkow



waldeck .



Oppeln

Schlesien

Schweidnitz

Mähren

Drabkow

Meseritz

Kassylow



Torgau

Waldeck

Wernberg



MARK BRANDENBURG unter den Askaniern (1320)

-  Markgrafschaft Brandenburg
-  Sonstige Erwerbungen der Askaniern
-  Deutsch-polnische Grenze

1373 - 1415

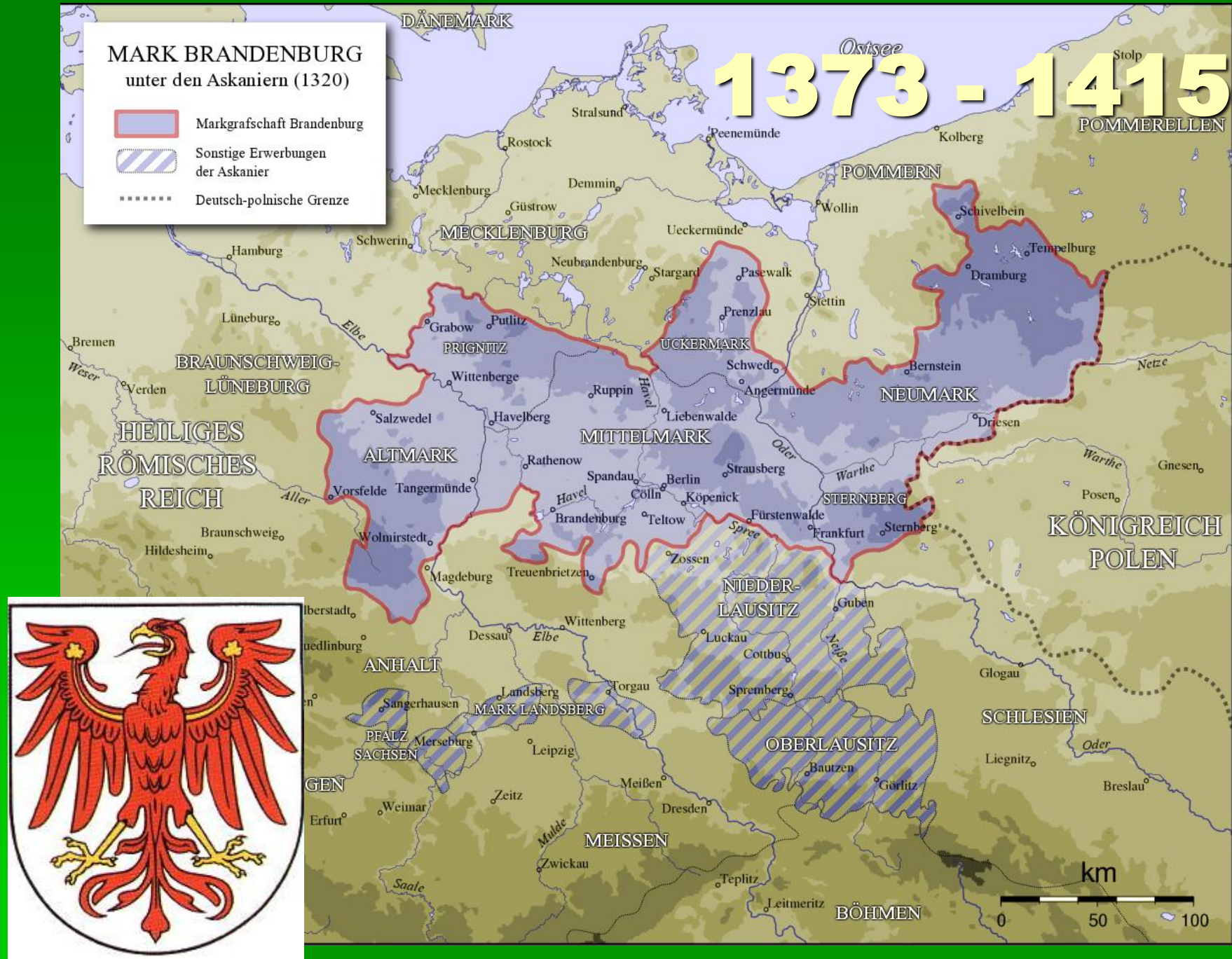

Tangermünde





Karlshaus

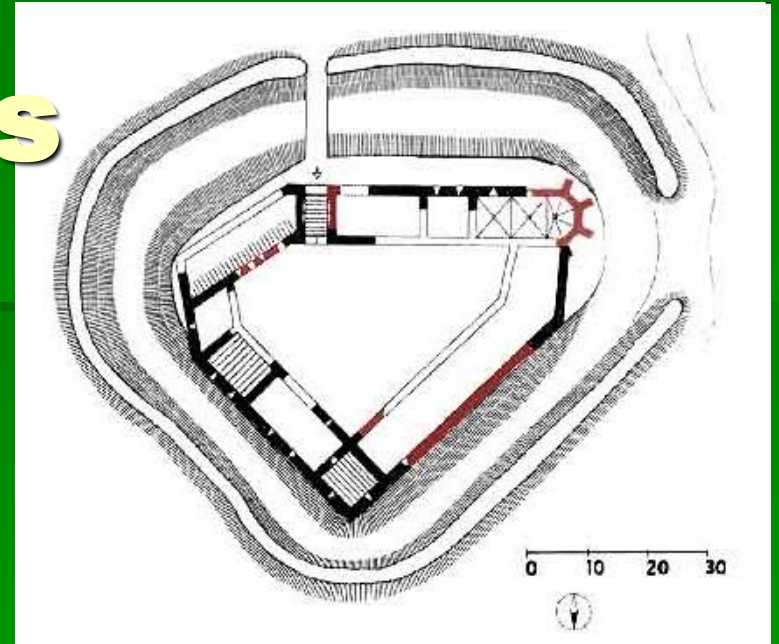

Karlsfried

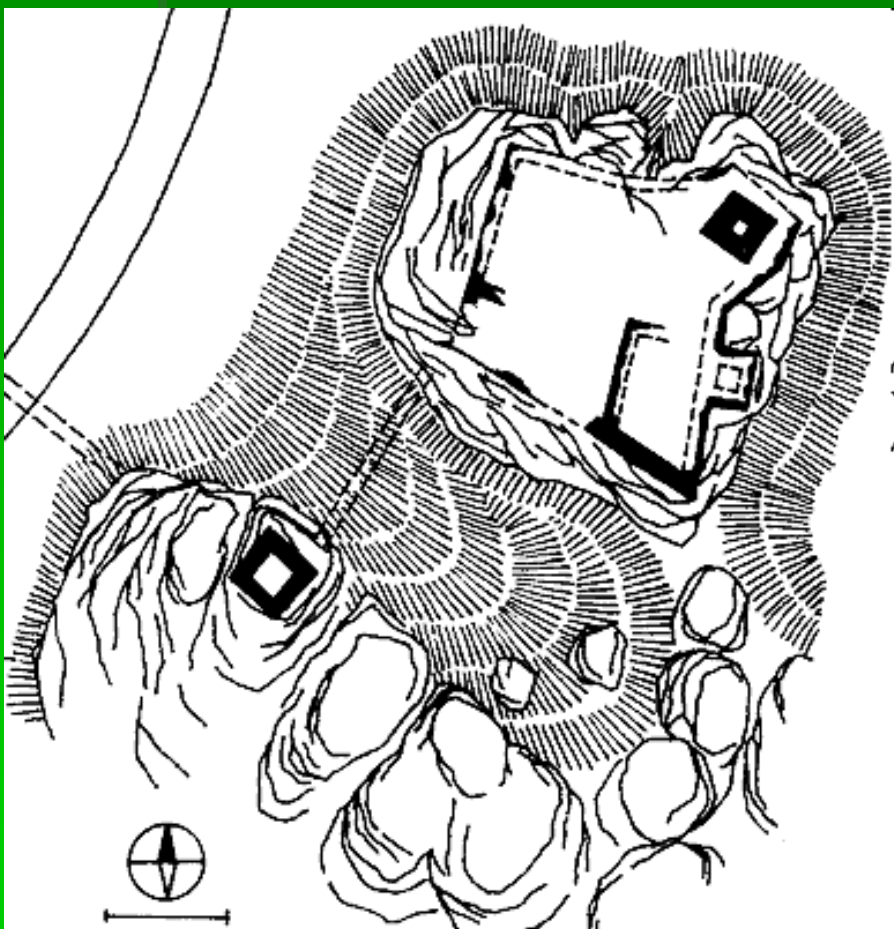

Horní Lužice

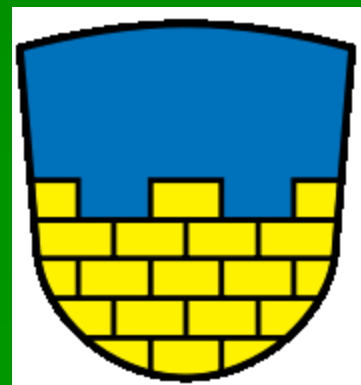

Celní hrad

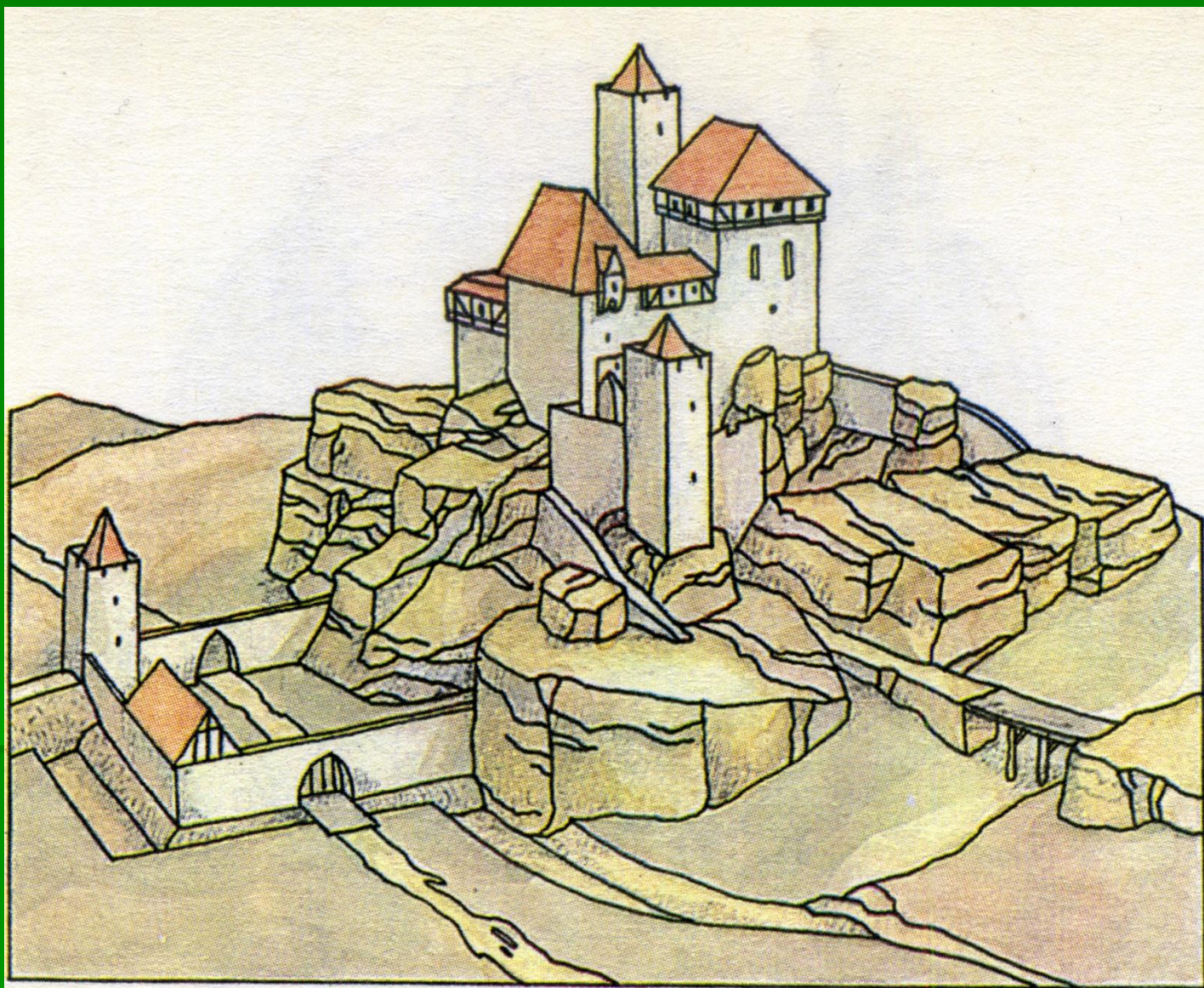

Zoll- und Geleitsburg Karlsfried (Rekonstruktion nach Scholze)

Hrad a klášter Ojvín (Oybin)

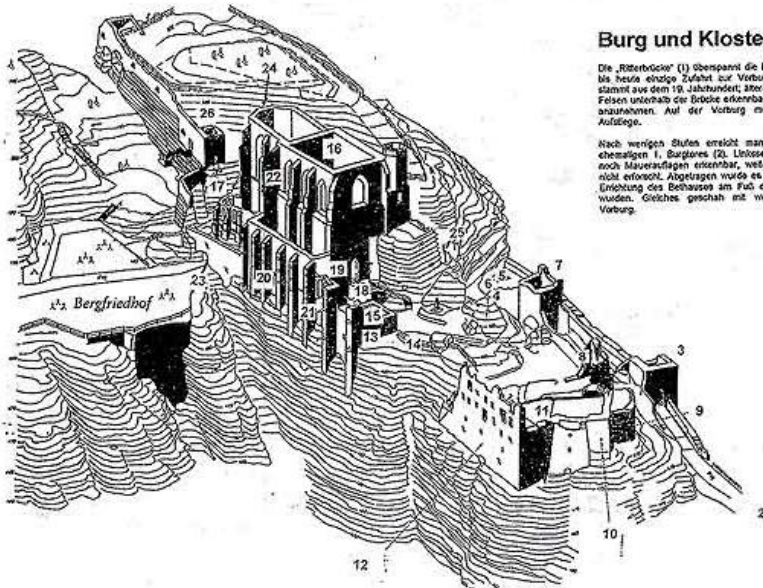
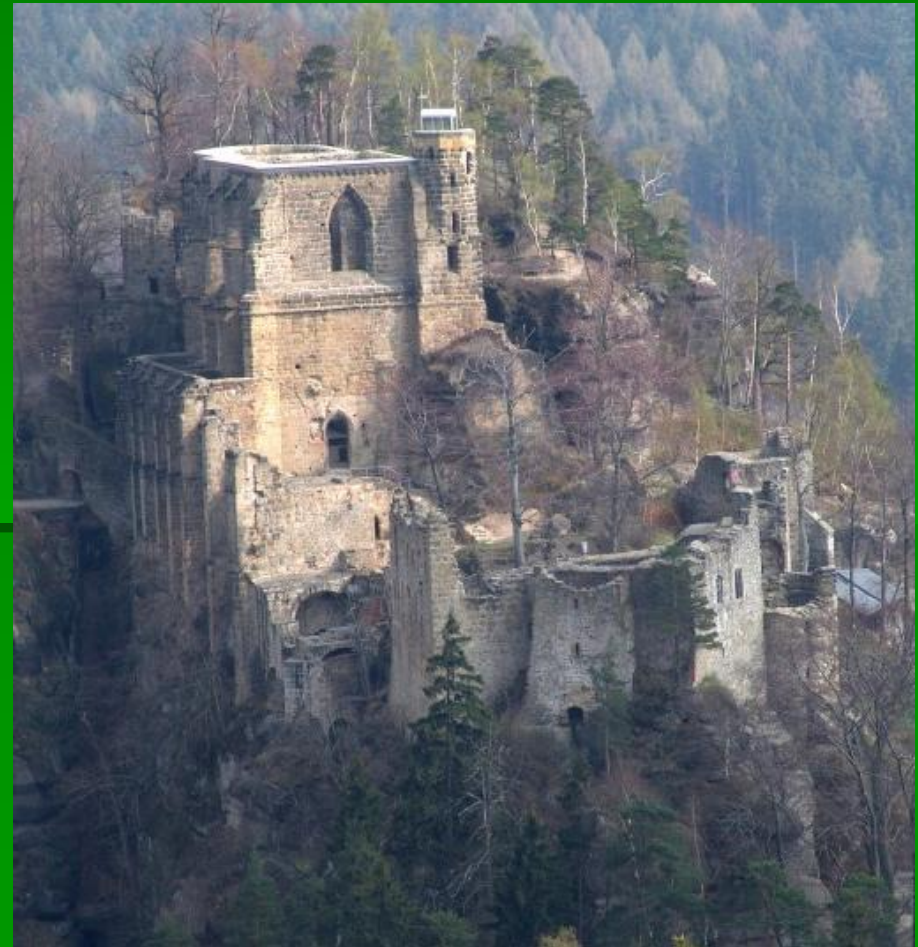

Burg und Kloster Oybin

Die „Ritterbrücke“ (1) überspannt die Ritterschlucht und ist bis heute einzige Zufahrt zur Vorkurg. Der jetzige Bau stammt aus dem 19. Jahrhundert; ältere Baupuren sind im Felsen unterhalb der Brücke erkennbar. Eine Zugbrücke ist anzunehmen. Auf der Vorkurg erschloß sich weitere Aufgänge.

Nach wenigen Stufen erreicht man den Standort des ehemaligen 1. Burgtores (2). Linienziegel am Felsen sind auch Maueranlagen erkennbar, weitere Baupuren noch nicht erforscht. Abgelagert wurde es 1200, da Steine zur Einleitung des Bachwassers am Fuß des Oybins verwendet wurden. Gleiches geschah mit weiteren Mauern der Vorkurg.



Karlovarský zámek



Pět sakrálních prostor hradu Karlštejna



- kaple sv. Kříže – velký donjon
- kostel P. Marie – Mariánská věž
- kaple sv. Kateřiny – Mariánská věž
- manská kaple sv. Mikuláše – císařský palác
- oratoř sv. Václava u císařovy ložnice

Hmotová rekonstrukce Karlštejna – 14. stol. a dnes

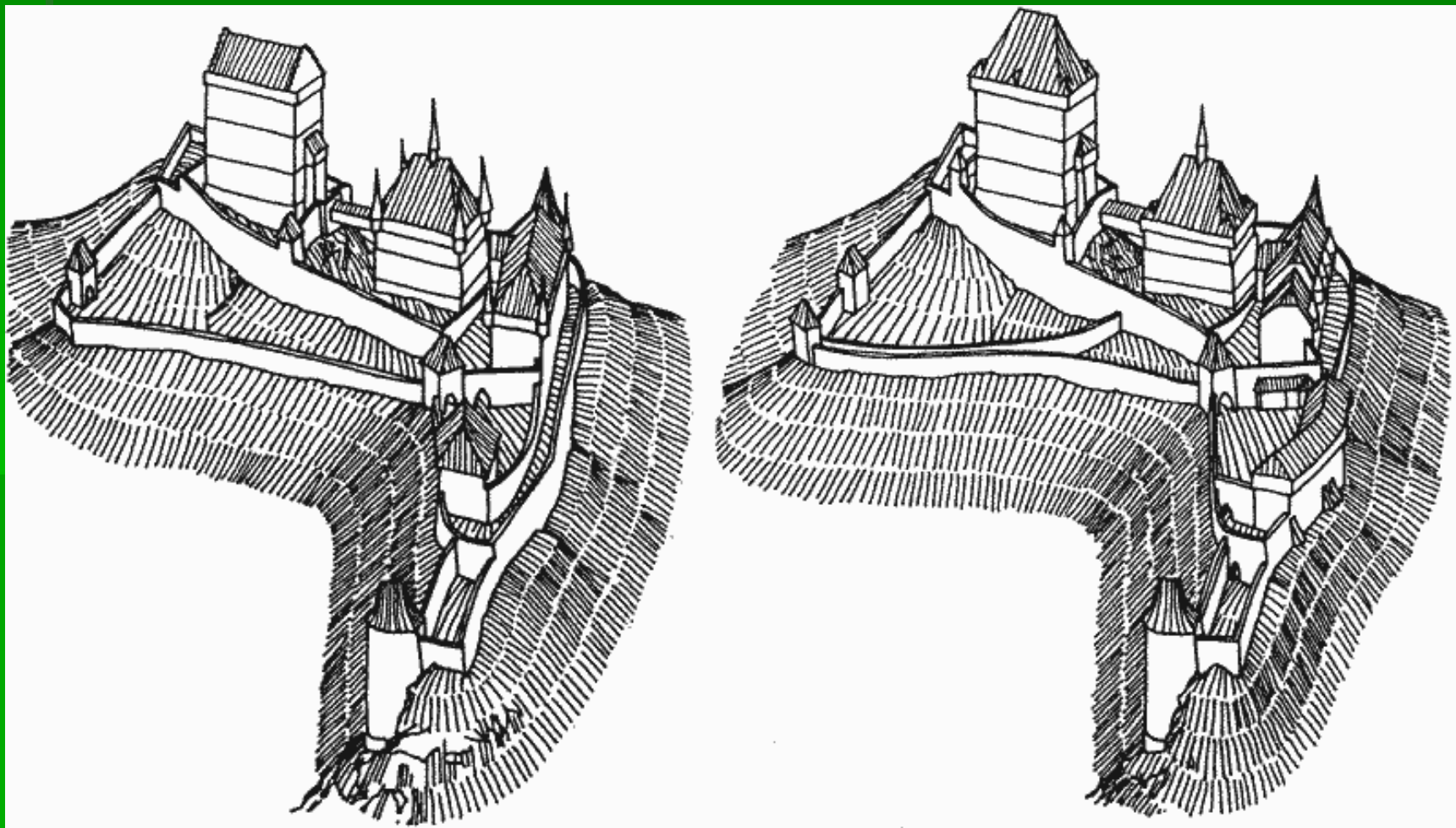

Řez donjony a palácem





Karlštejnské kaple

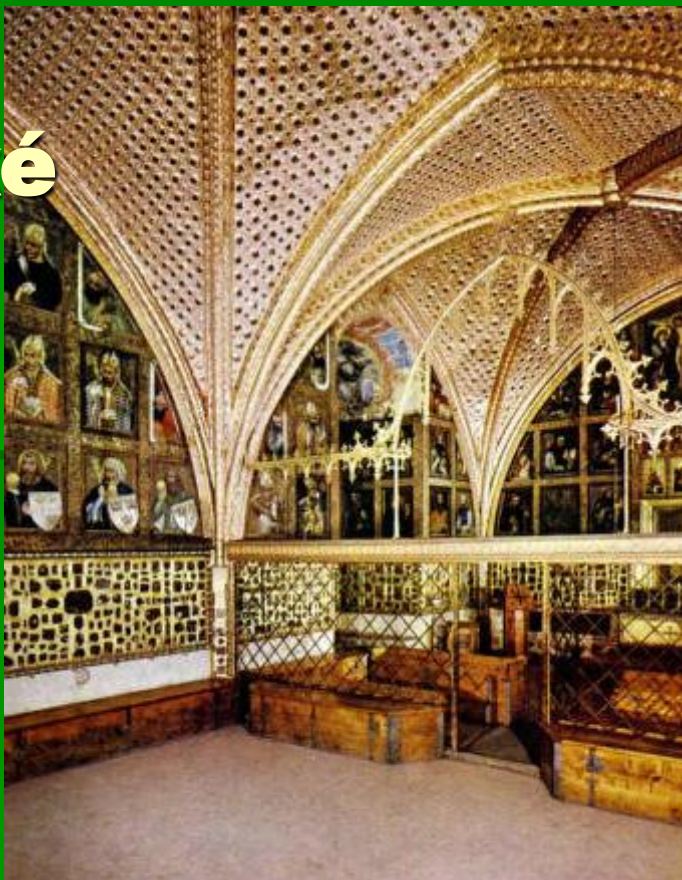

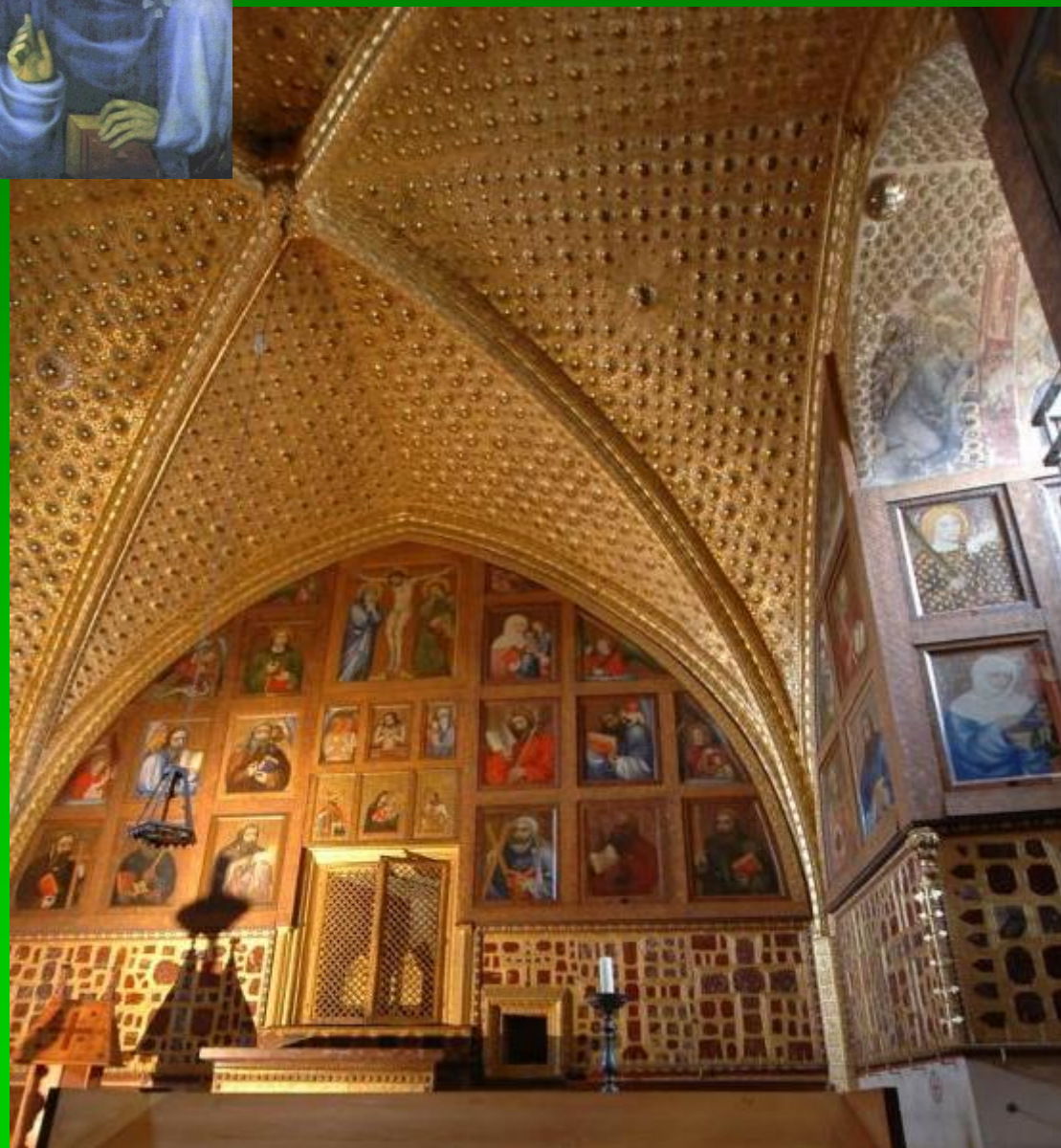

129 obrazů Mistra Theodorika Zelo



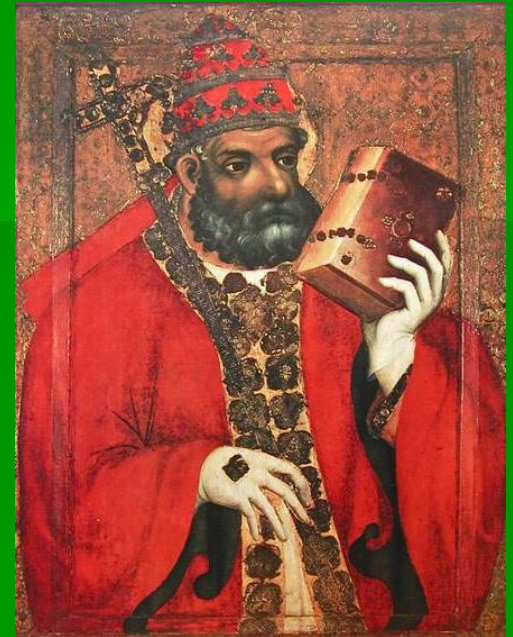
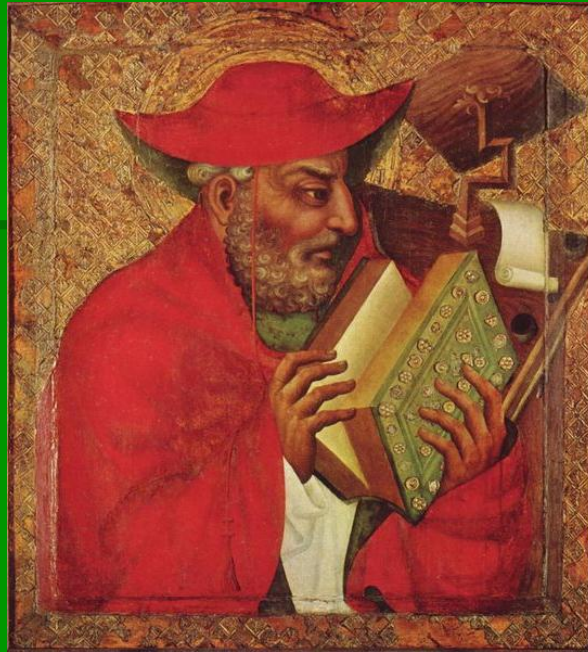

Smolotely – karlštejnské manství

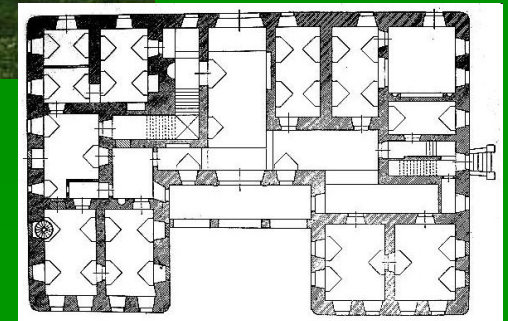

Oldřich Tista z Hedčan – magister fabricae

Libštejn

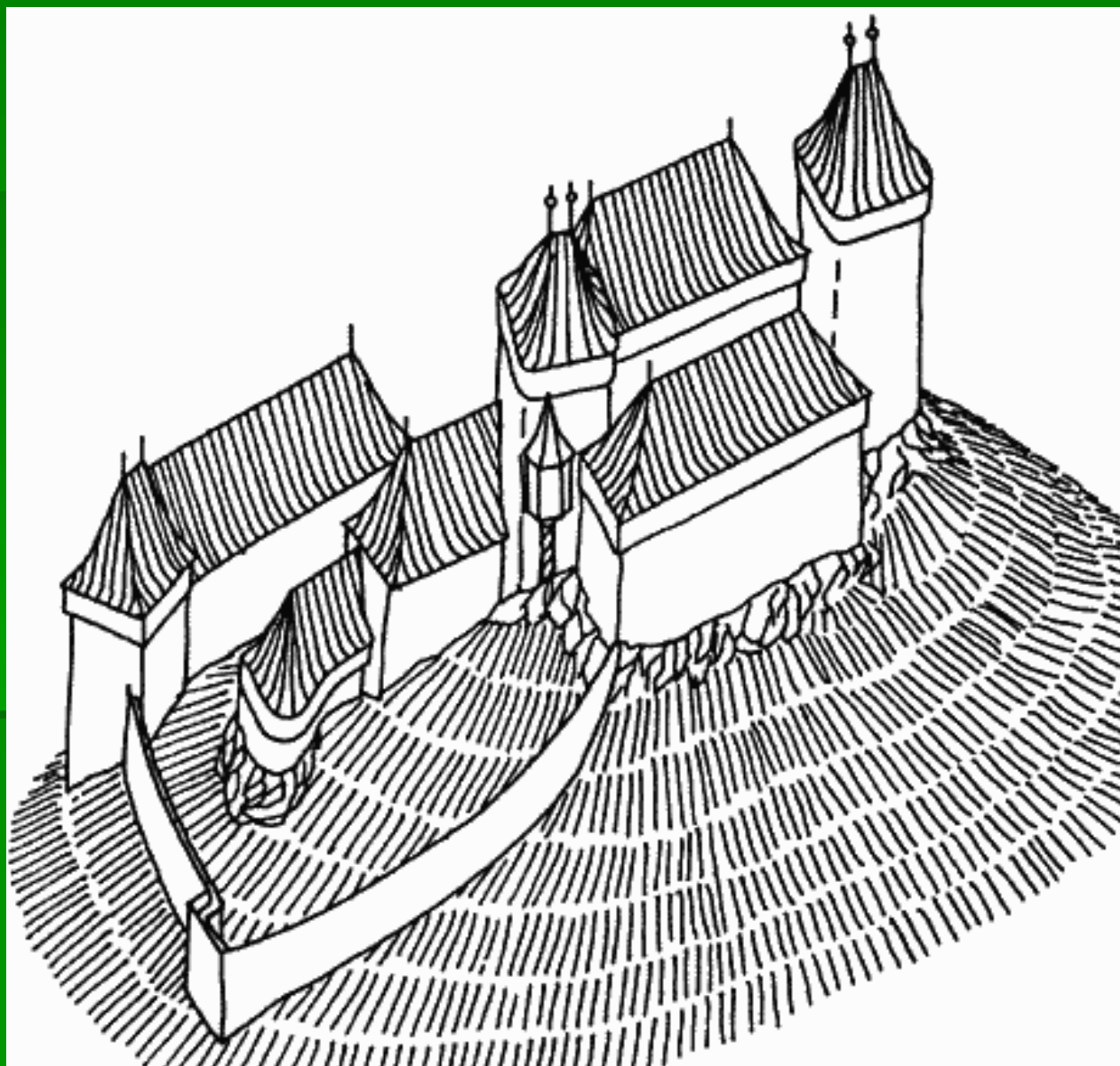

Vítkovci



Vítek z Prčice
(† 1194)

Jindřich

páni z Hradce

zlatá růže na
modrém poli



Vítek II.

páni
z Krumlova

zelená růže
na stříbrném
poli



Vítek III.

páni
z Rožmberka

červená růže
na stříbrném
poli



Vítek IV.

páni
z Landštejna
a Třeboně

stříbmá růže
na červeném
poli



Sezema
(Sezima)

páni
ze Sezimova
Ústí

černá růže na
zlatém poli



páni
ze Stráže

modrá růže na
zlatém poli



Maidštejn – Dívčí kámen



Dvoupalácová dispozice

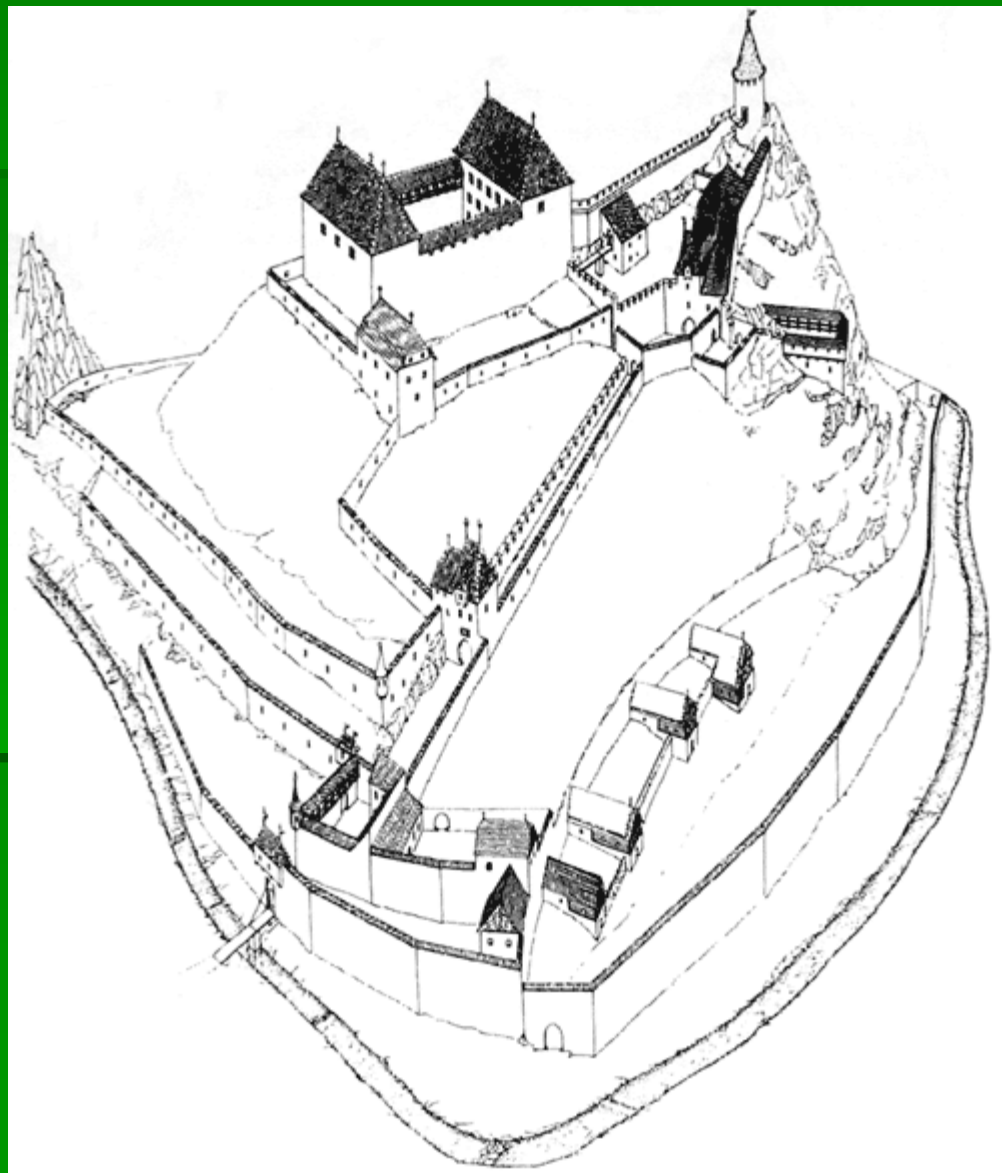
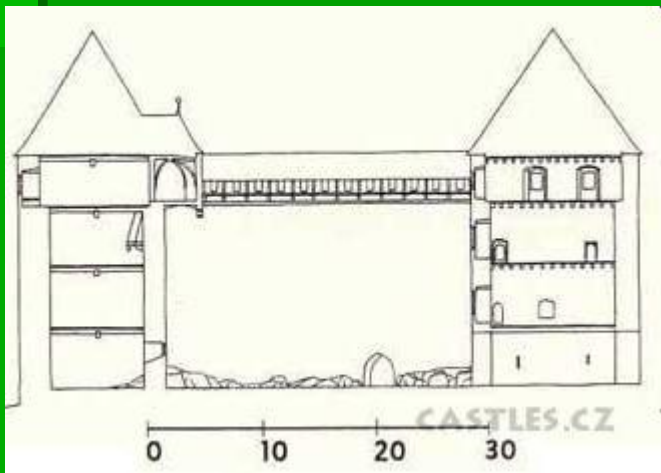

Dívčí kámen

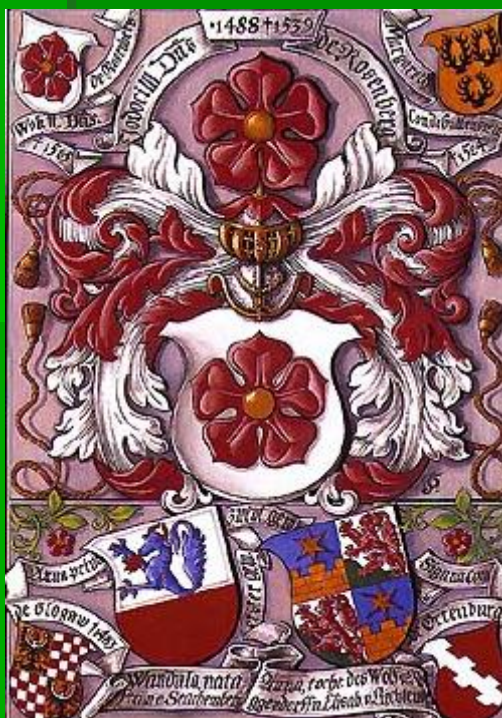

Helpfenburk u Bavorova

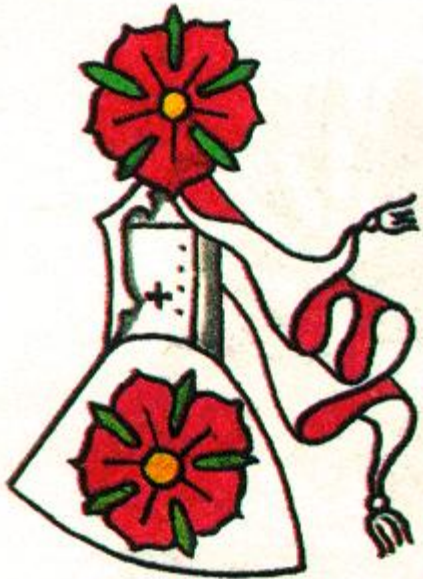
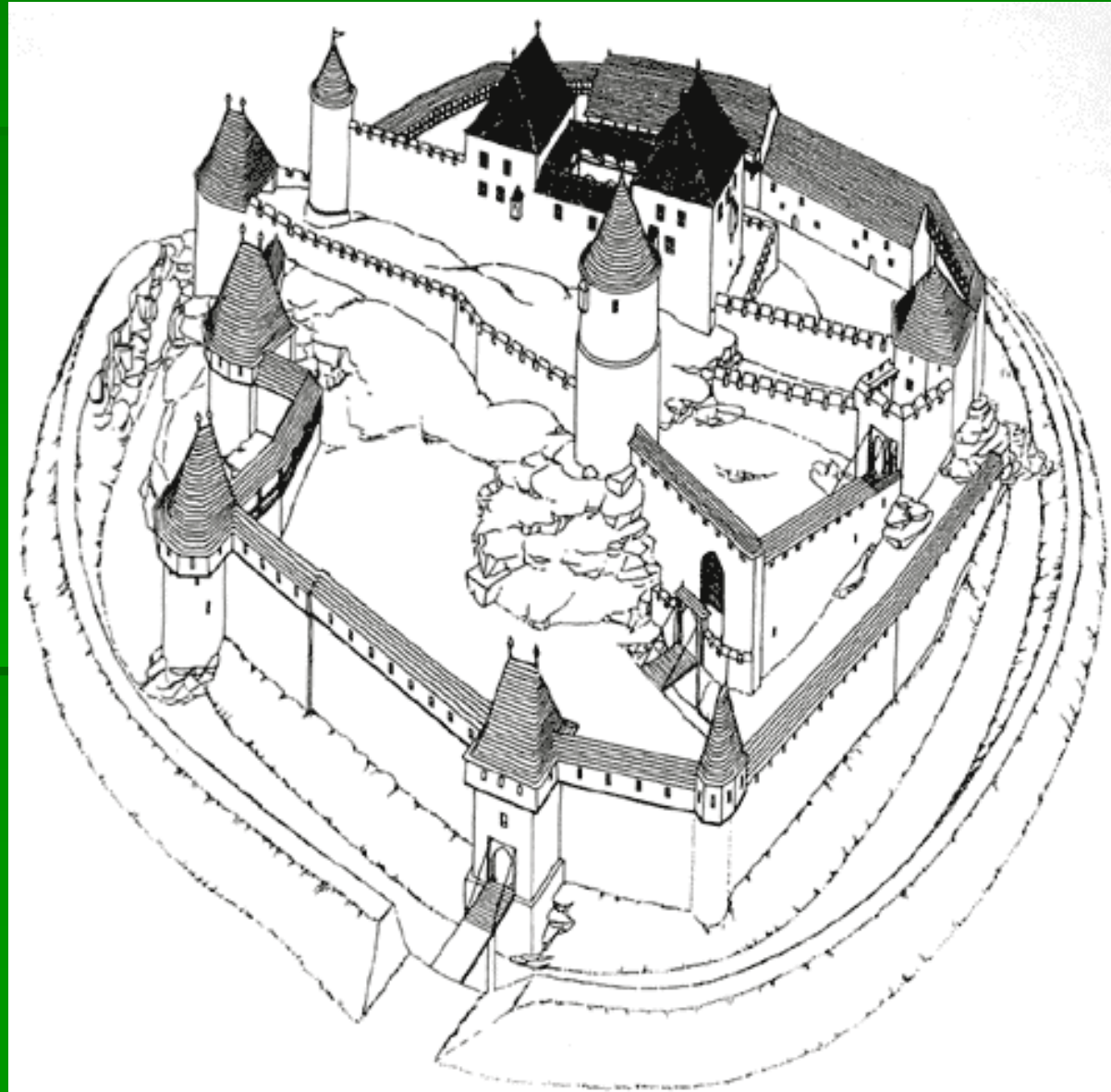

Helpenburk dnes



Valečov

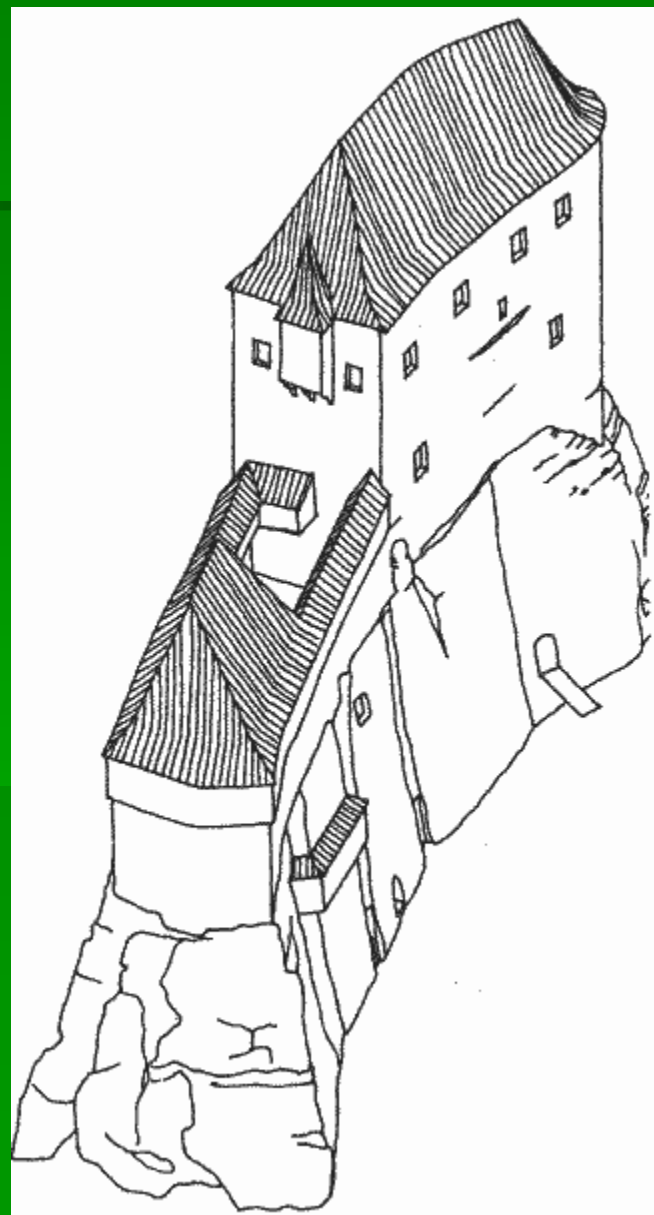
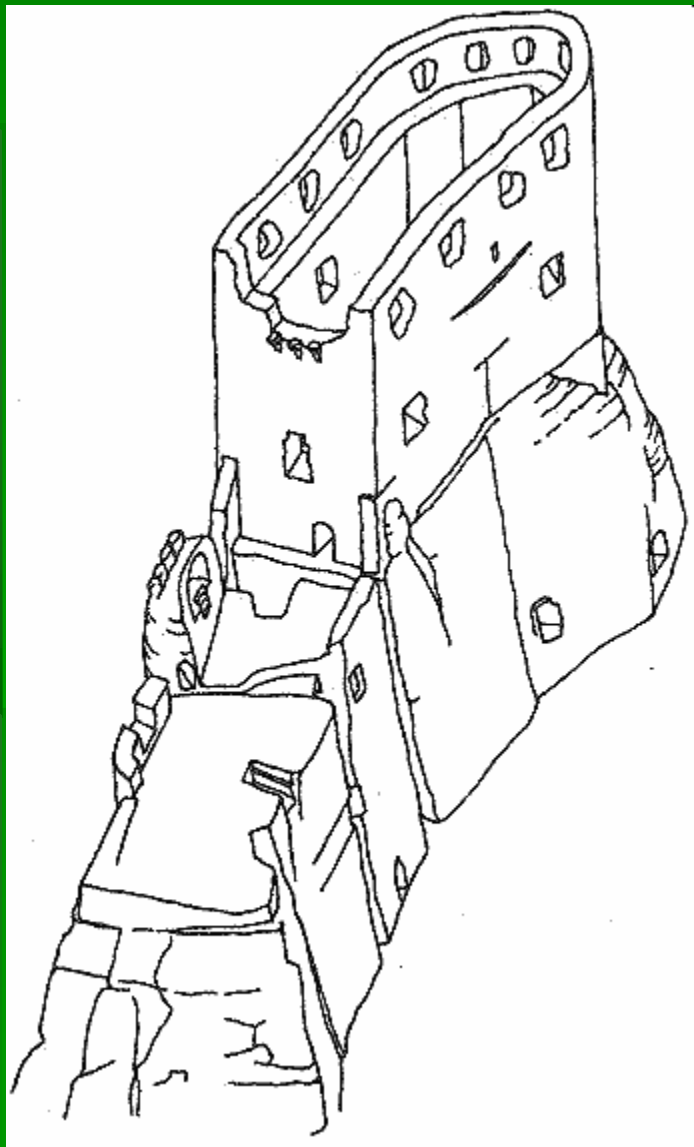

Skalní hrad

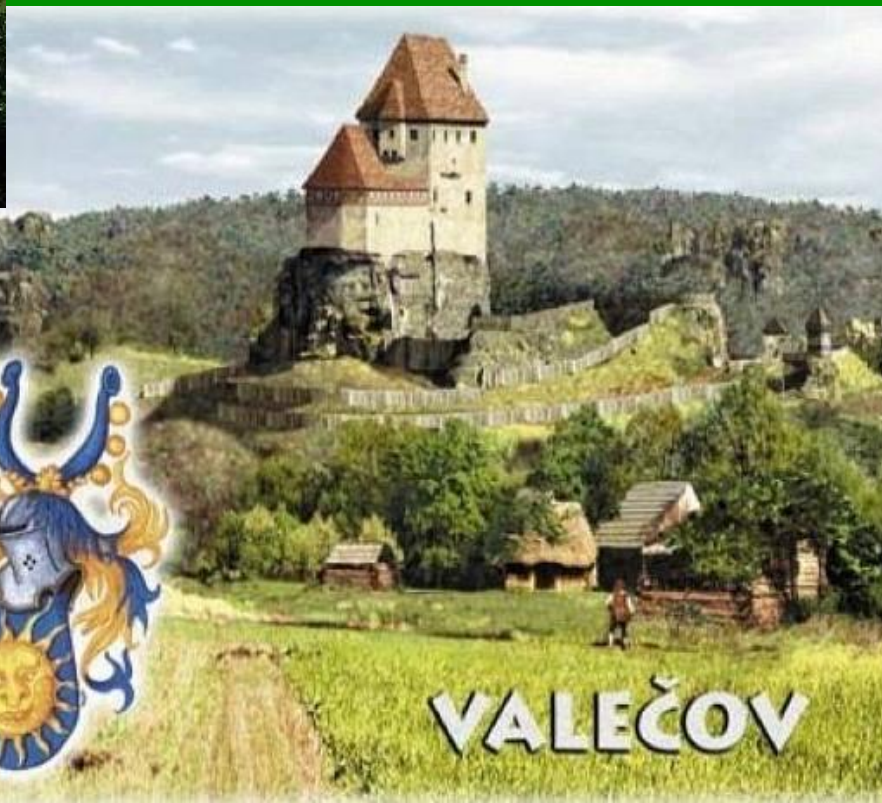

Hrad Kost pánů z Vartenberka



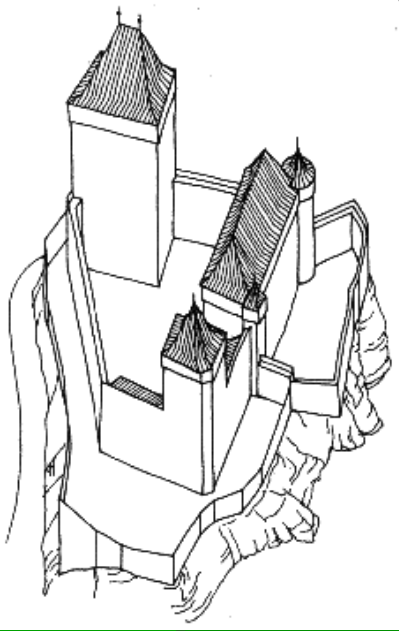

Vartenberský hrad Kost

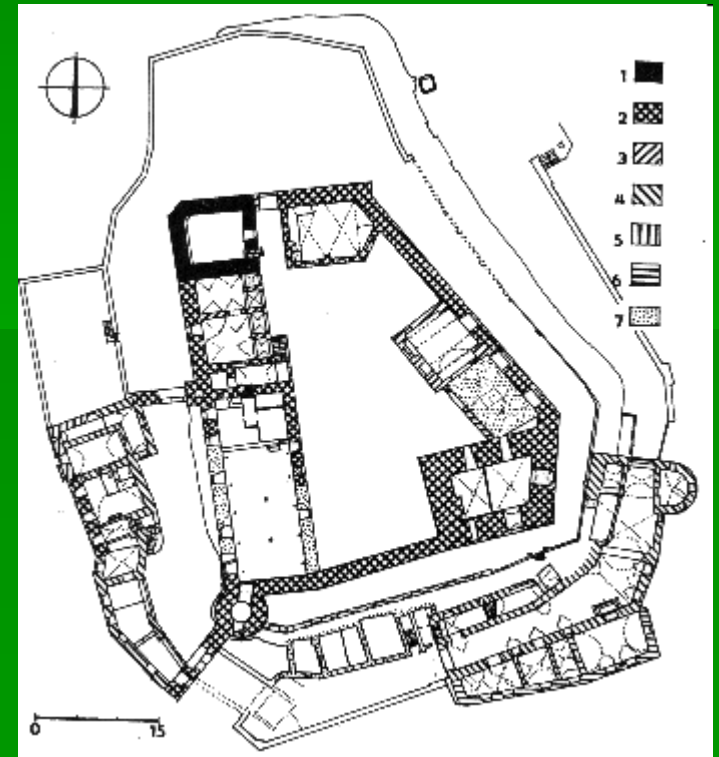



Boršengrýn Boreš z Rýzmburka

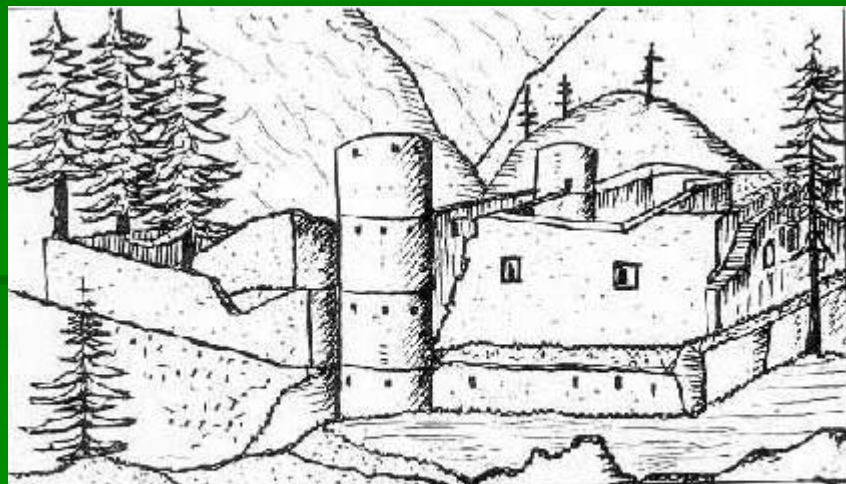

Obrázek 4. Nejstarší známá podoba zříceniny Boršengrýnu z roku 1683, překreslená Friedrichem BERNAUEM.

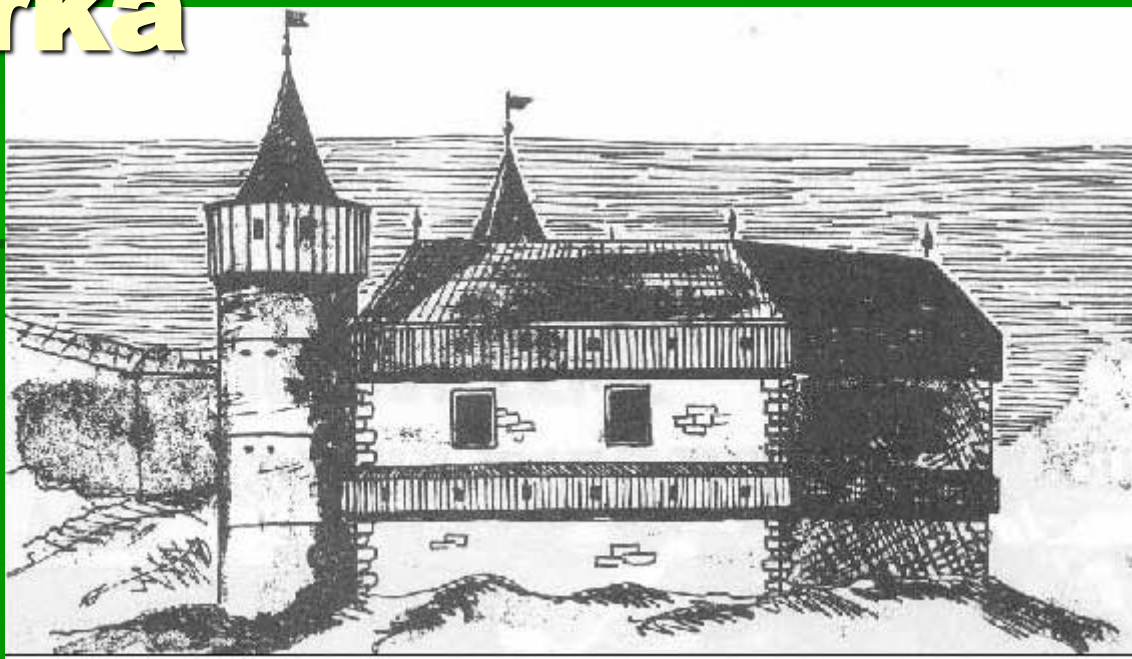

Potštejn 1339 dobyt markrabětem Karlem

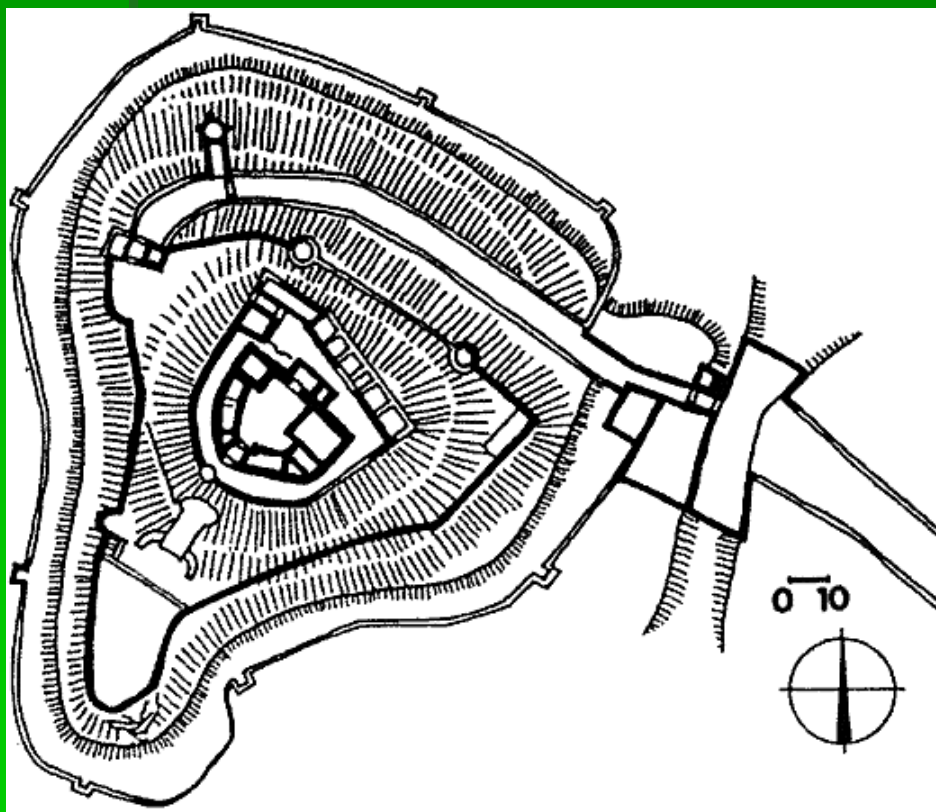

- 1355 – 1359
byl hrad Karlem IV.
obnoven

Jan Pancíř ze Smojna

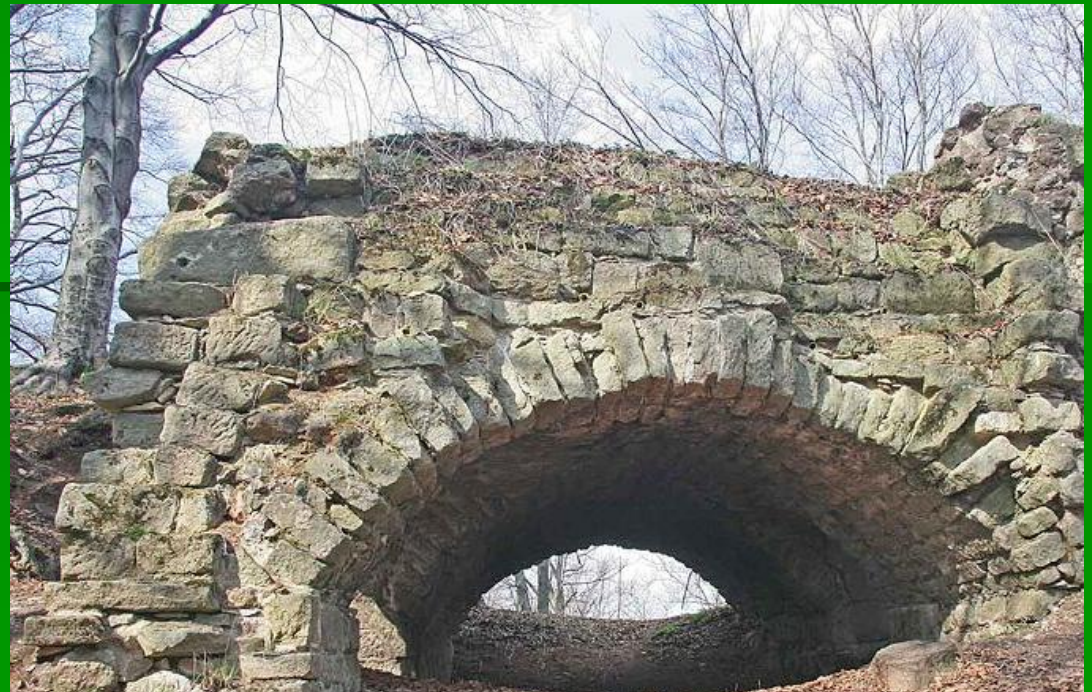
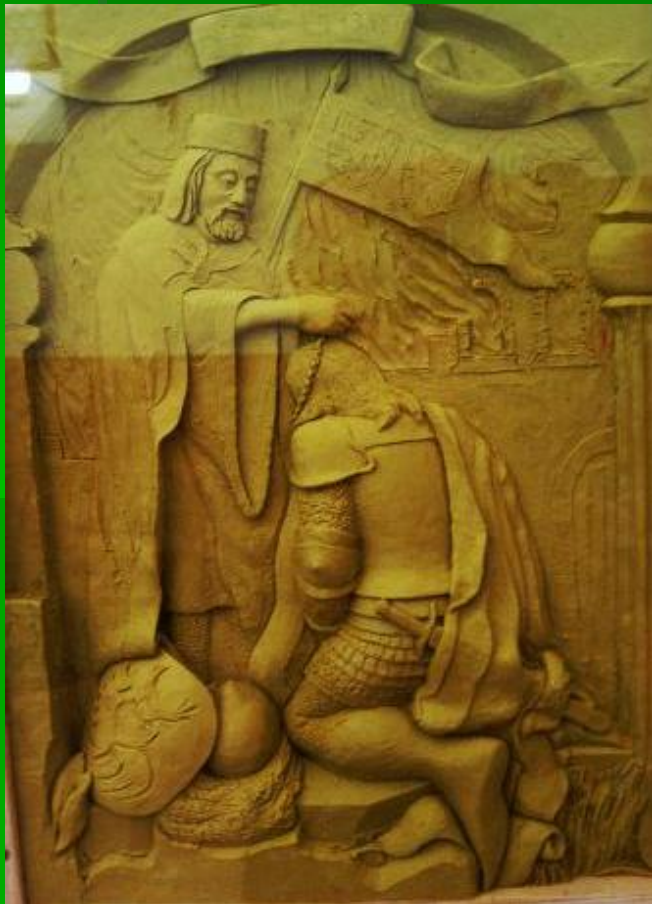
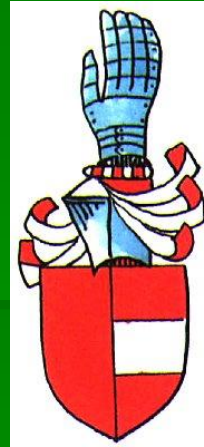

Období krásného slohu za Václava IV. 1378 - 1419



Krásný sloh



Staroměstská mostecká věž



Staroměstská mostecká věž

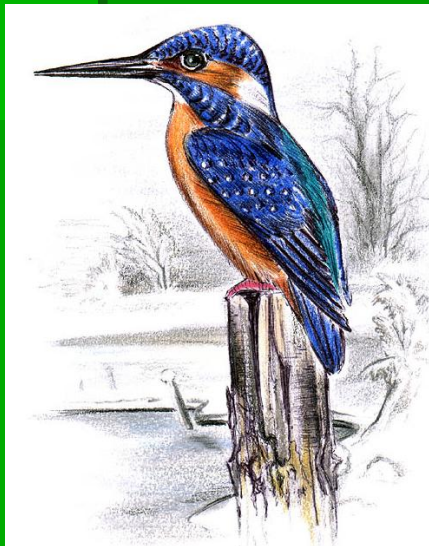

Iluminované rukopisy Václava IV.

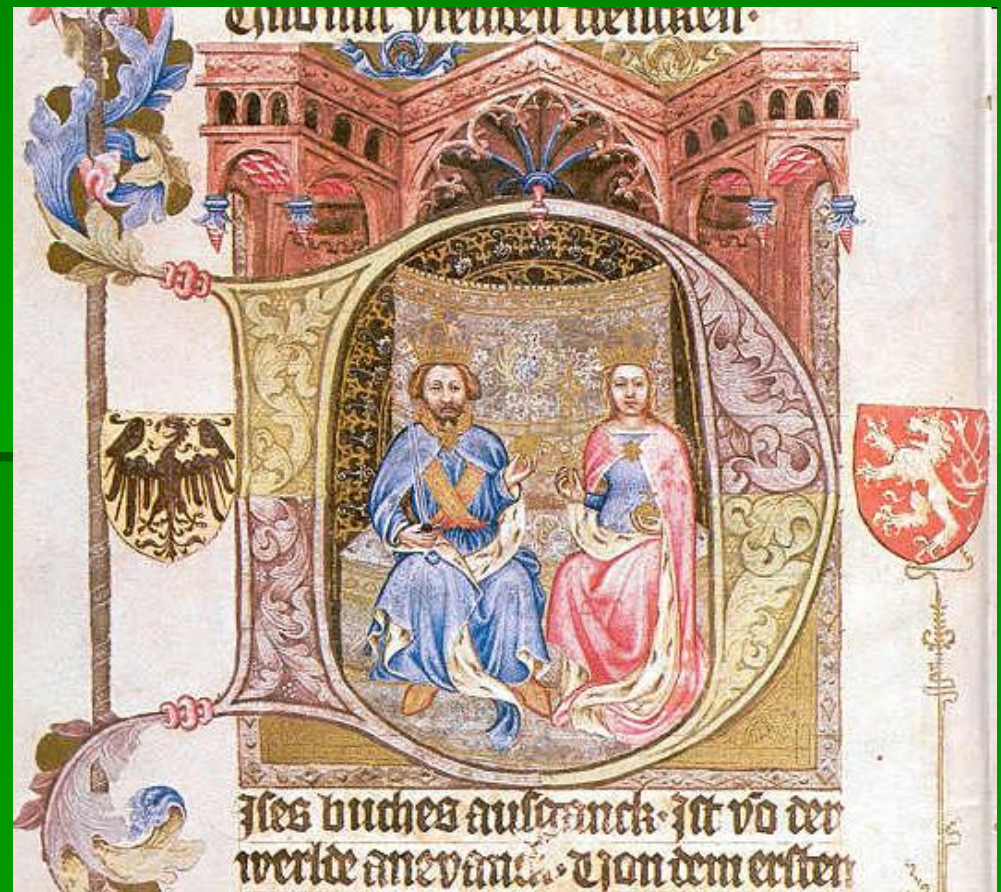



Václav IV. a lazebnice Zuzana



Žebrák a Točník

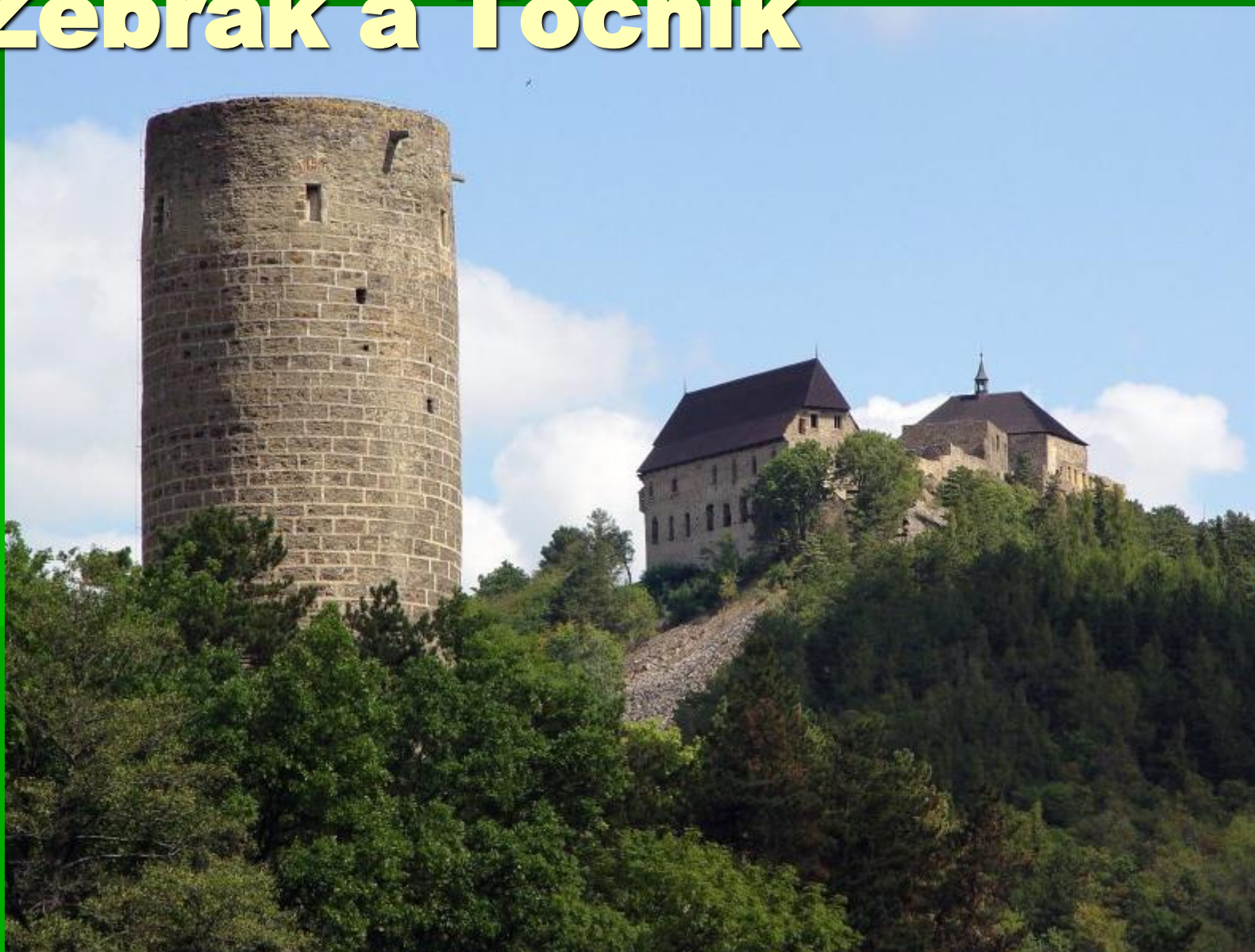

Točník

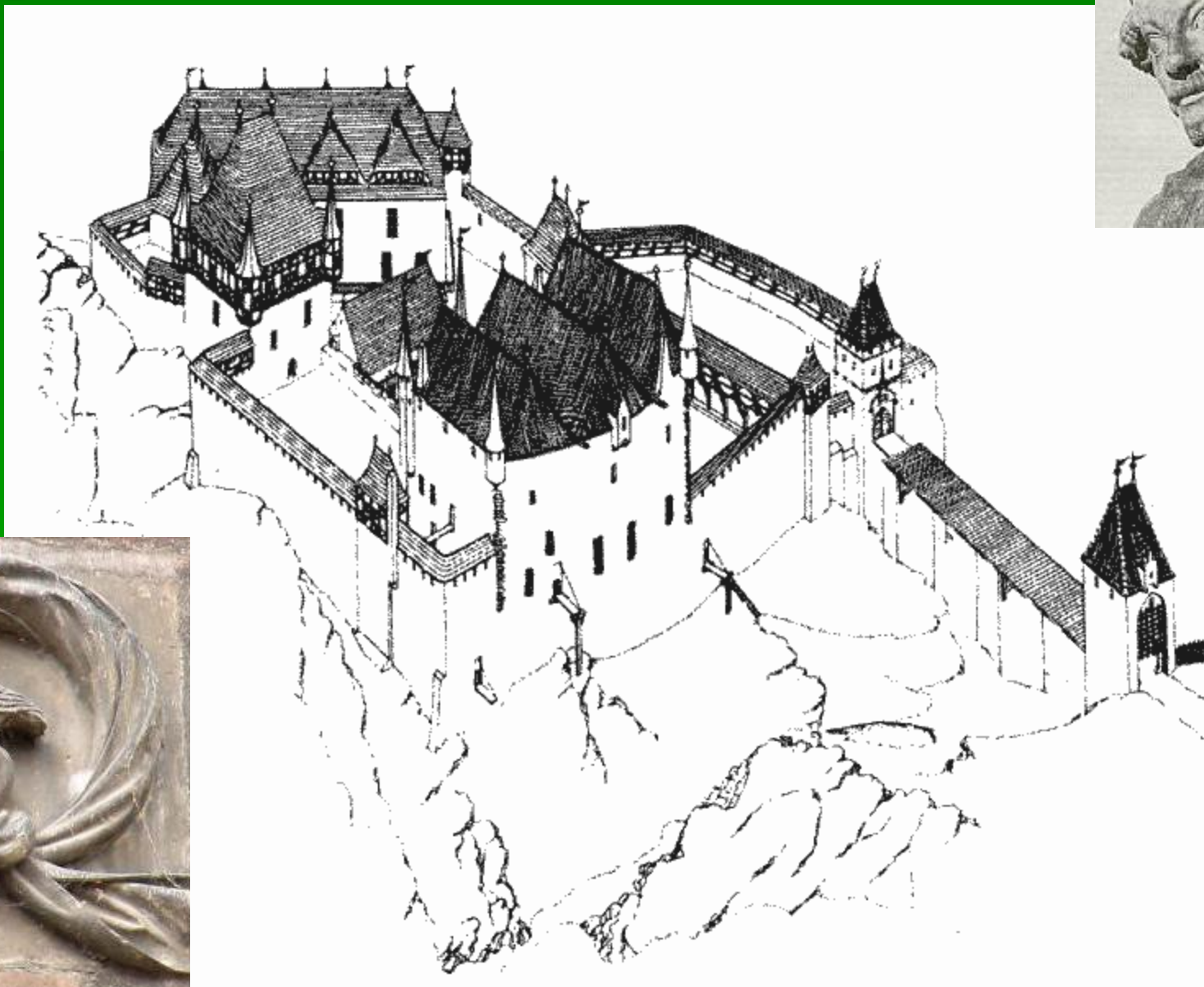



Točník

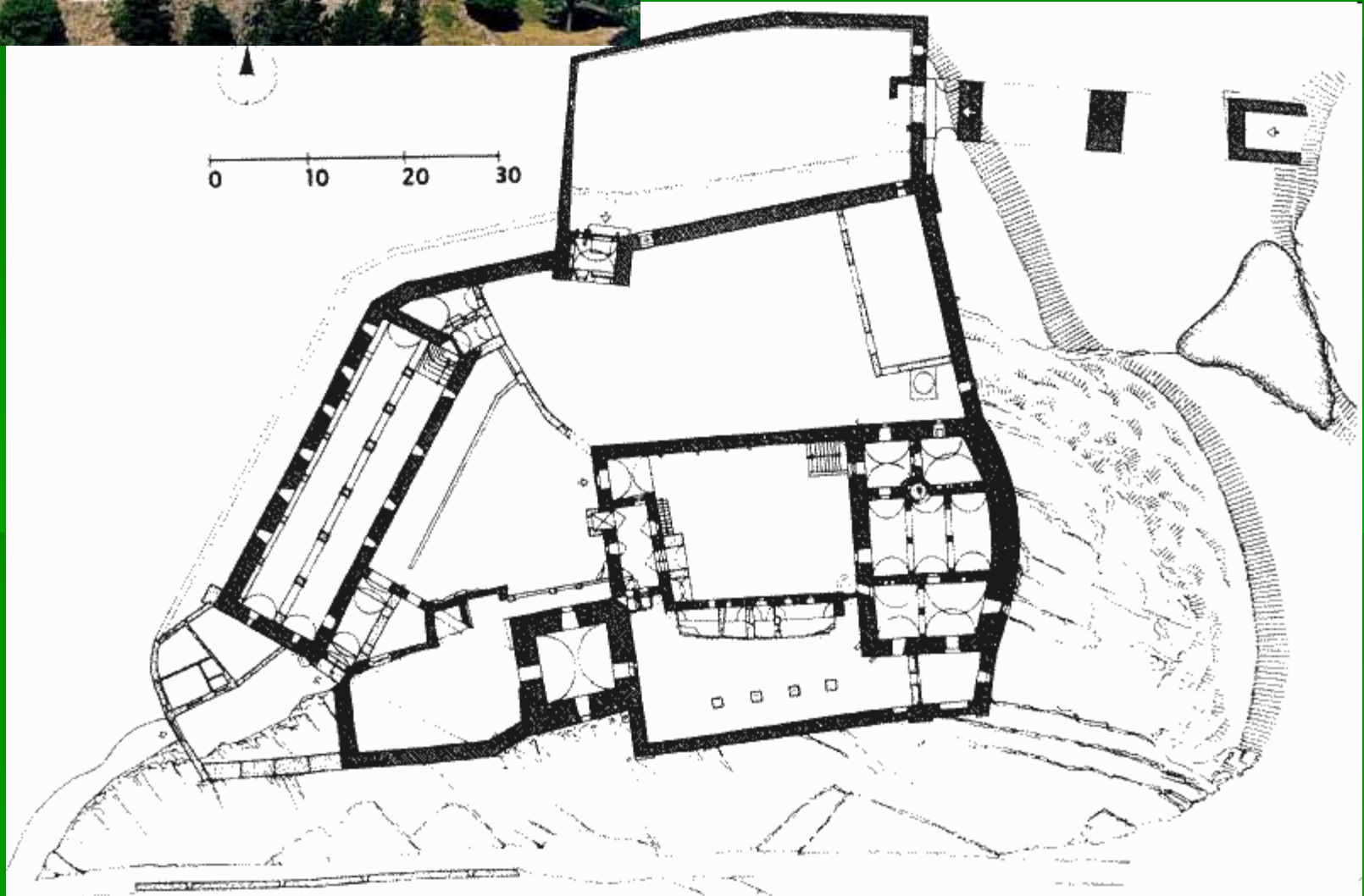



Královský palác



Purkrabský palác na Točníku



Žebrák

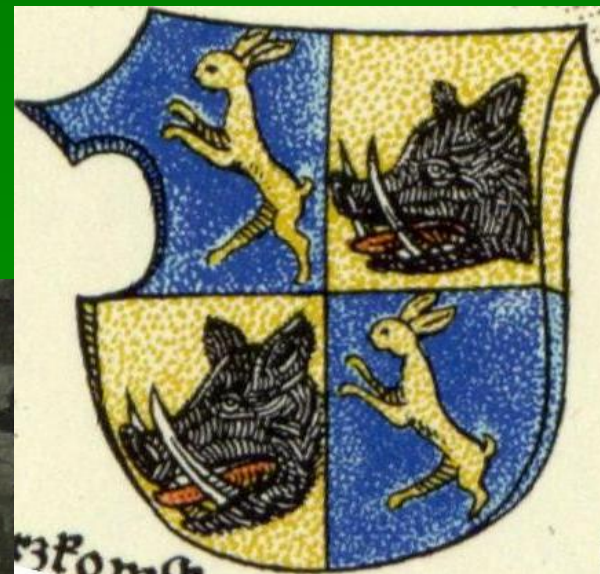

Starý a nový palác portál do věže





Nový palác na Žebráku

Jenštejn

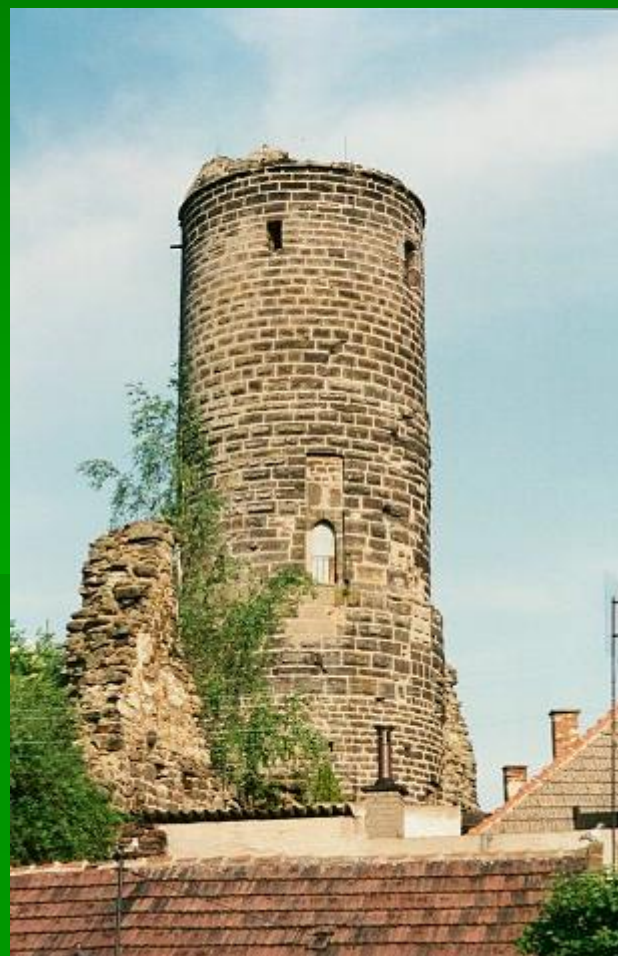

Hrádek na Zderaze

- Hrádek postaven Václavem IV. kolem r. 1380. V 17. stol. přestavěn na klášter a později na trestnici, 1901-1905 vše zbořeno a hradní skála byla odlámána.



Obr. 80: Hrádek na Zderaze. Nahoře hrad na Schedelově vedutě Prahy z roku 1493, dole zpustlý hrad v roce 1606 na Sadelerově vedutě Prahy.

Nový hrad u Kunratic

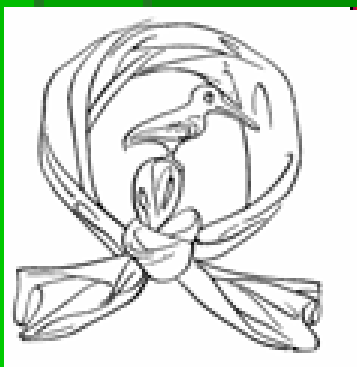
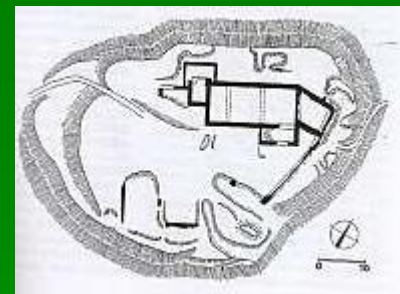

Vlašský dvůr kaple sv. Václava

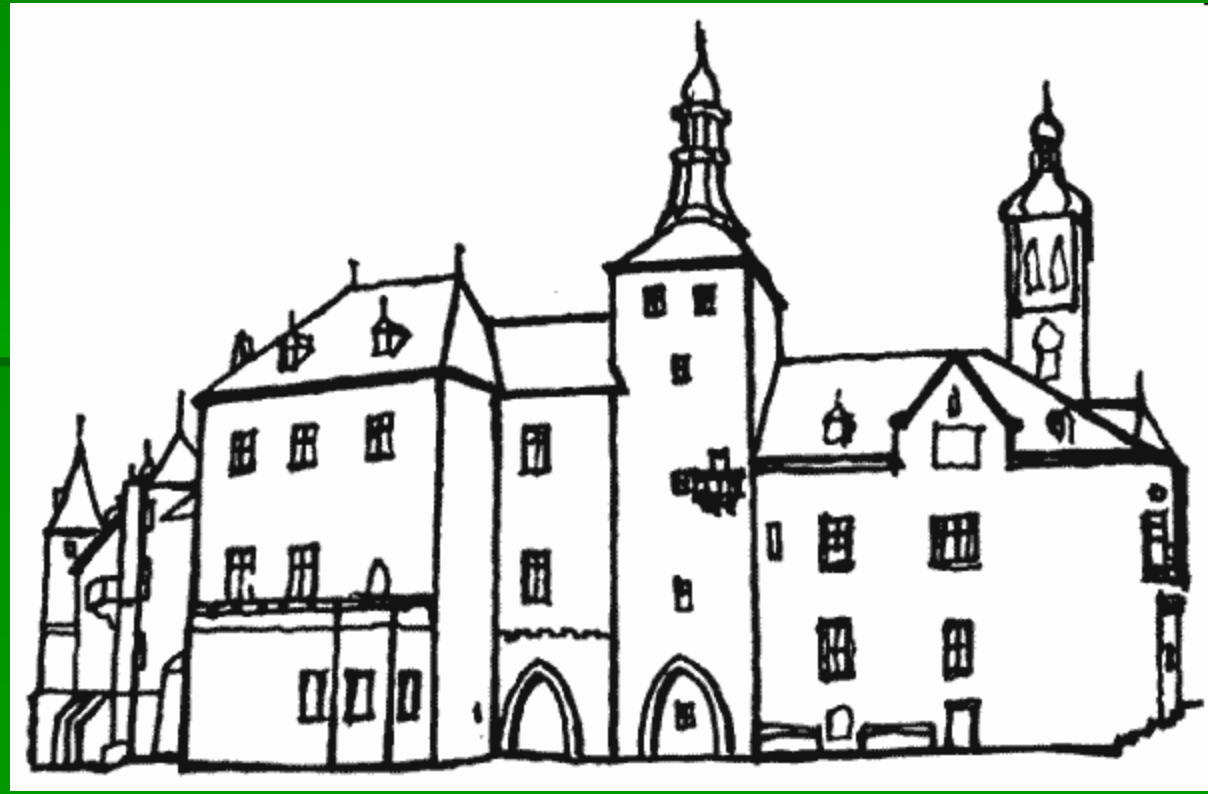
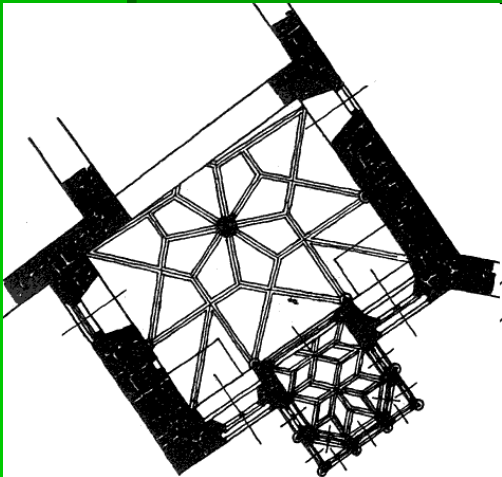

Krakovec

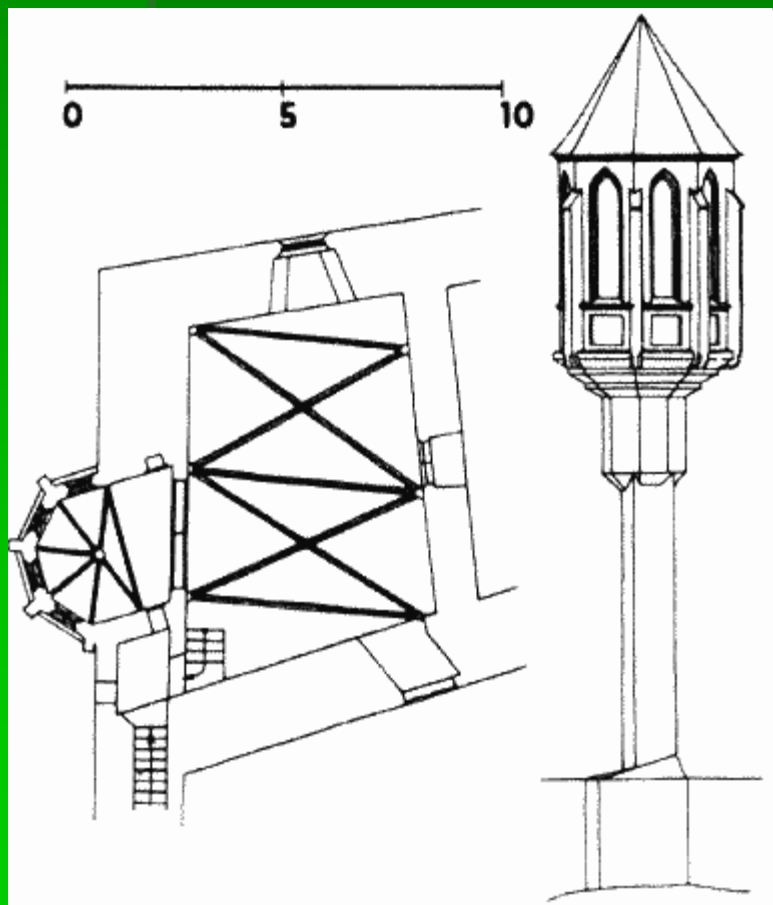



Krakovec

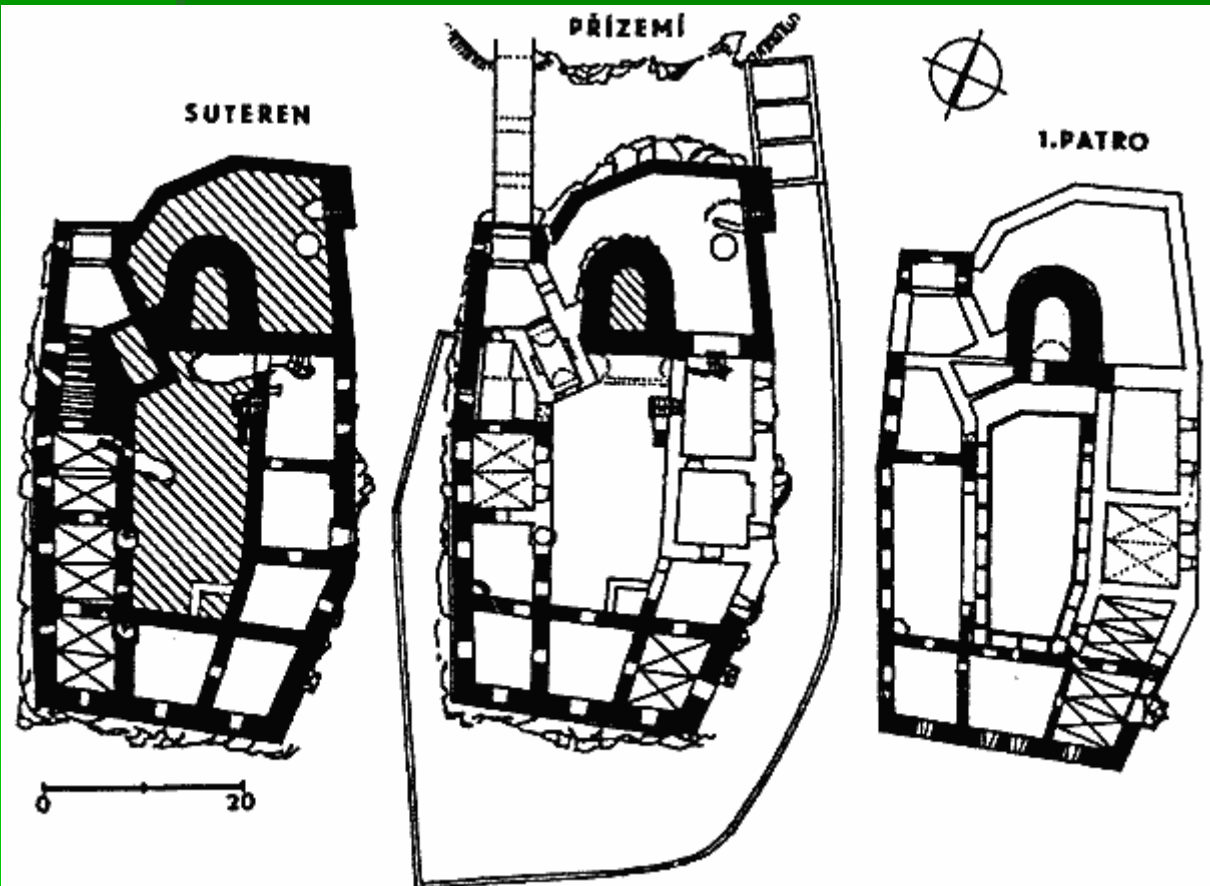



Jindřich Lefl z Lažan



Husitské války 1419 - 1434



Husitská obléhací artilerie

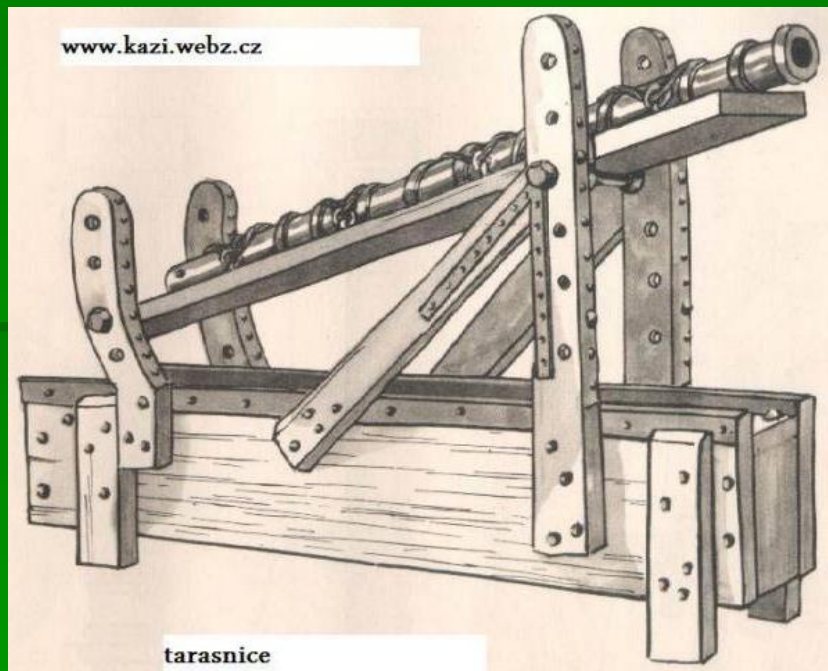

tarasnice

www.mojezapady.cz

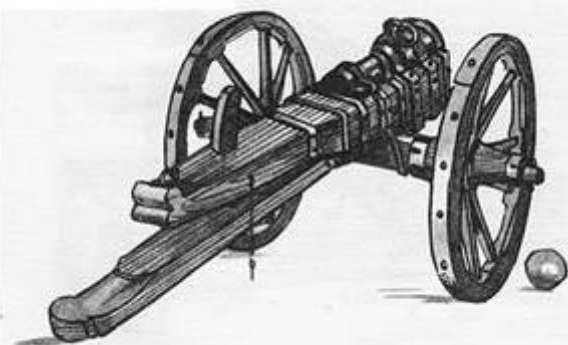

bombardy





1421

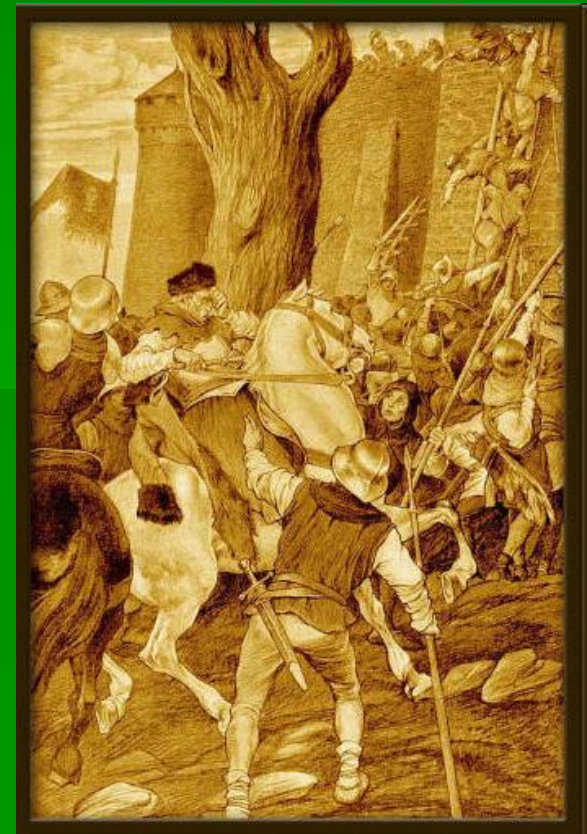



Říčany

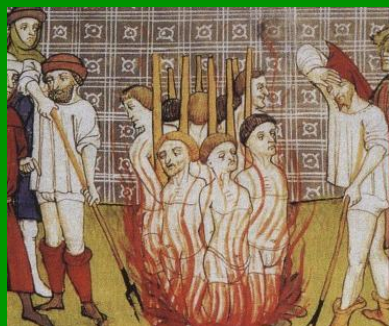
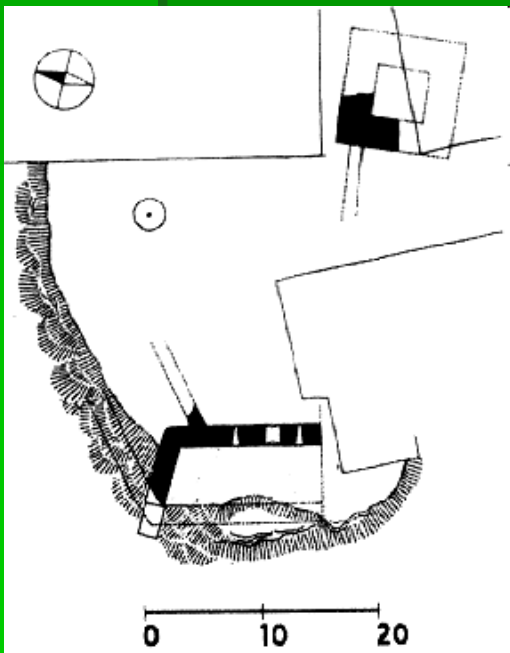



Hrad Kalich

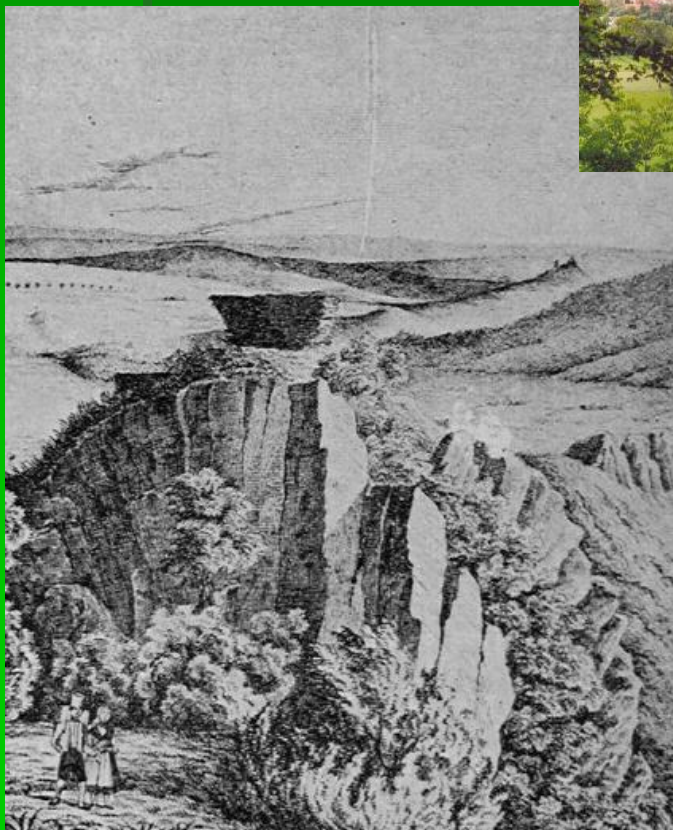
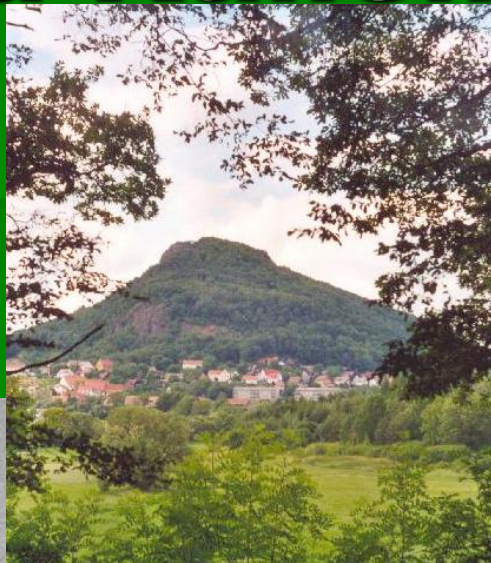

KALICH, půdorys hradu podle F. Gabriela a J. Smetany.

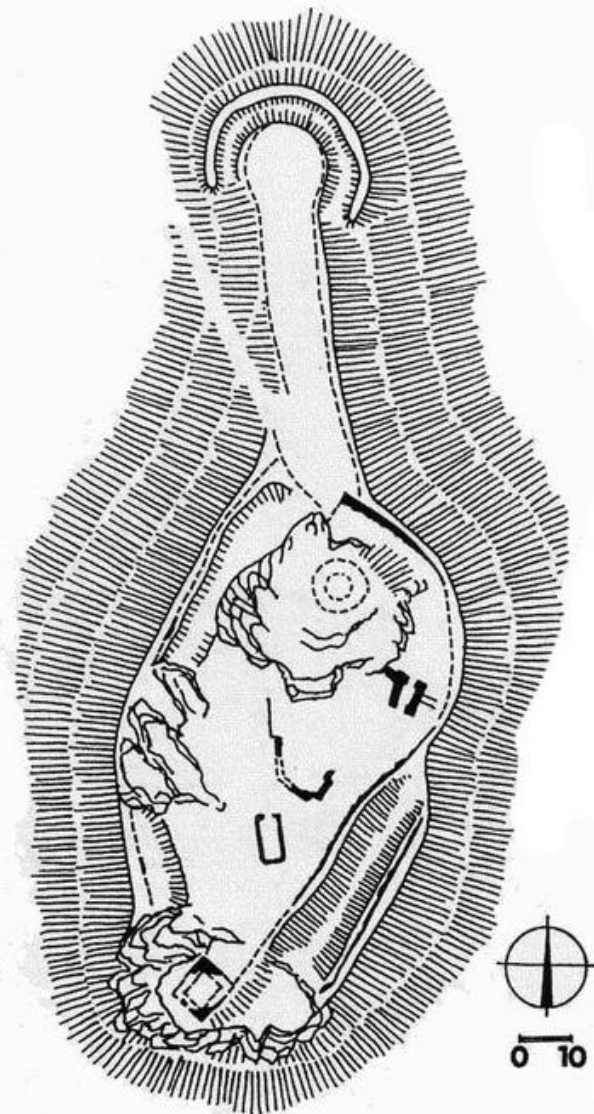

Zdroj: DURDÍK, T. Ilustrovaná encyklopedie českých hradů. Praha : Libri, 2002, s. 237.



Oltářík - hrad husitského hejtmana Jakoubka z Vřesovic

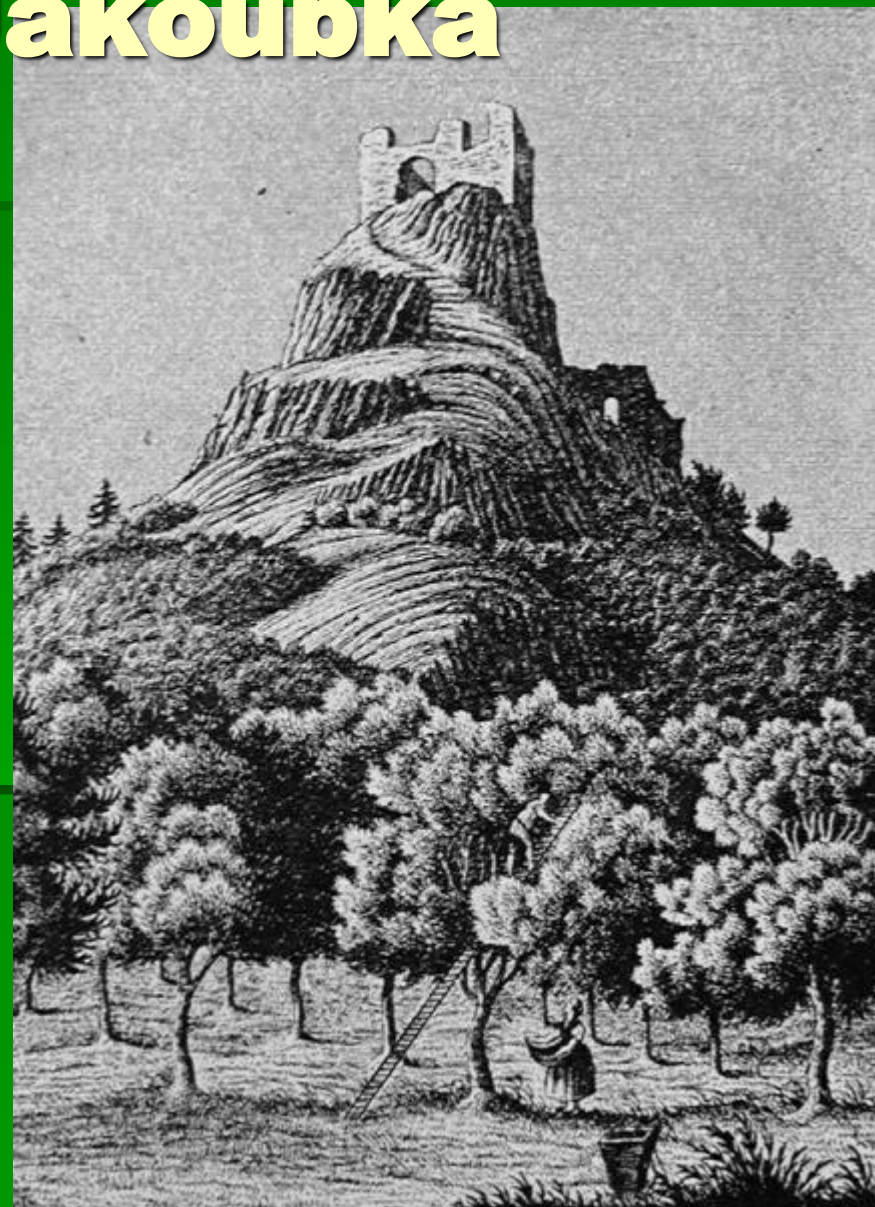
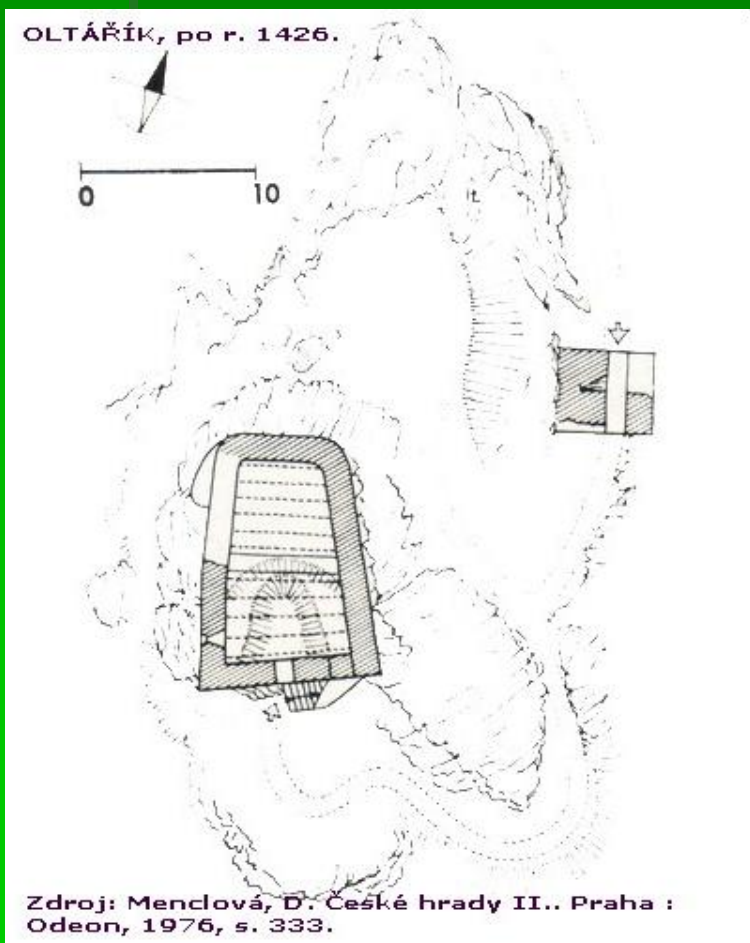

Drábské světničky



Sion Jana Roháče z Dubé

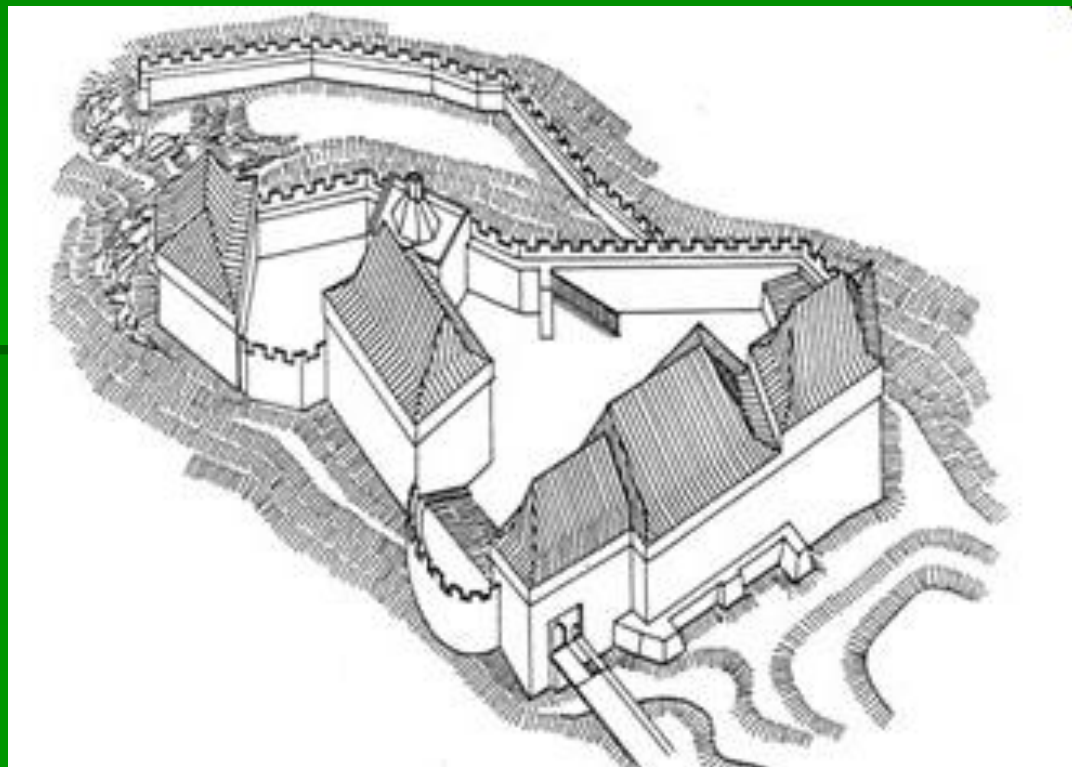



Omyl Mikoláše Alše

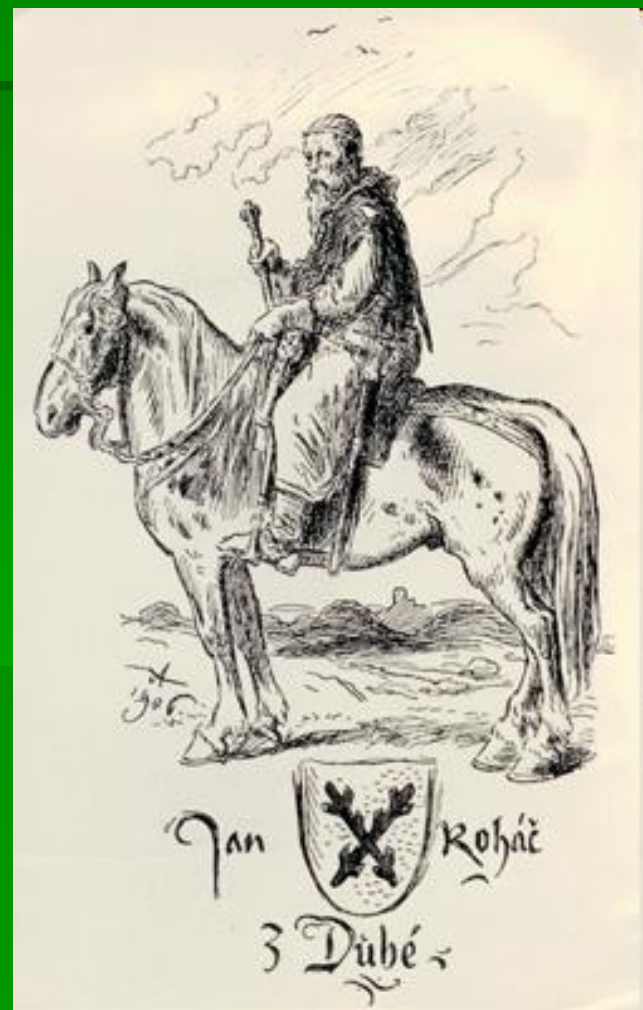



Cherchez la femme

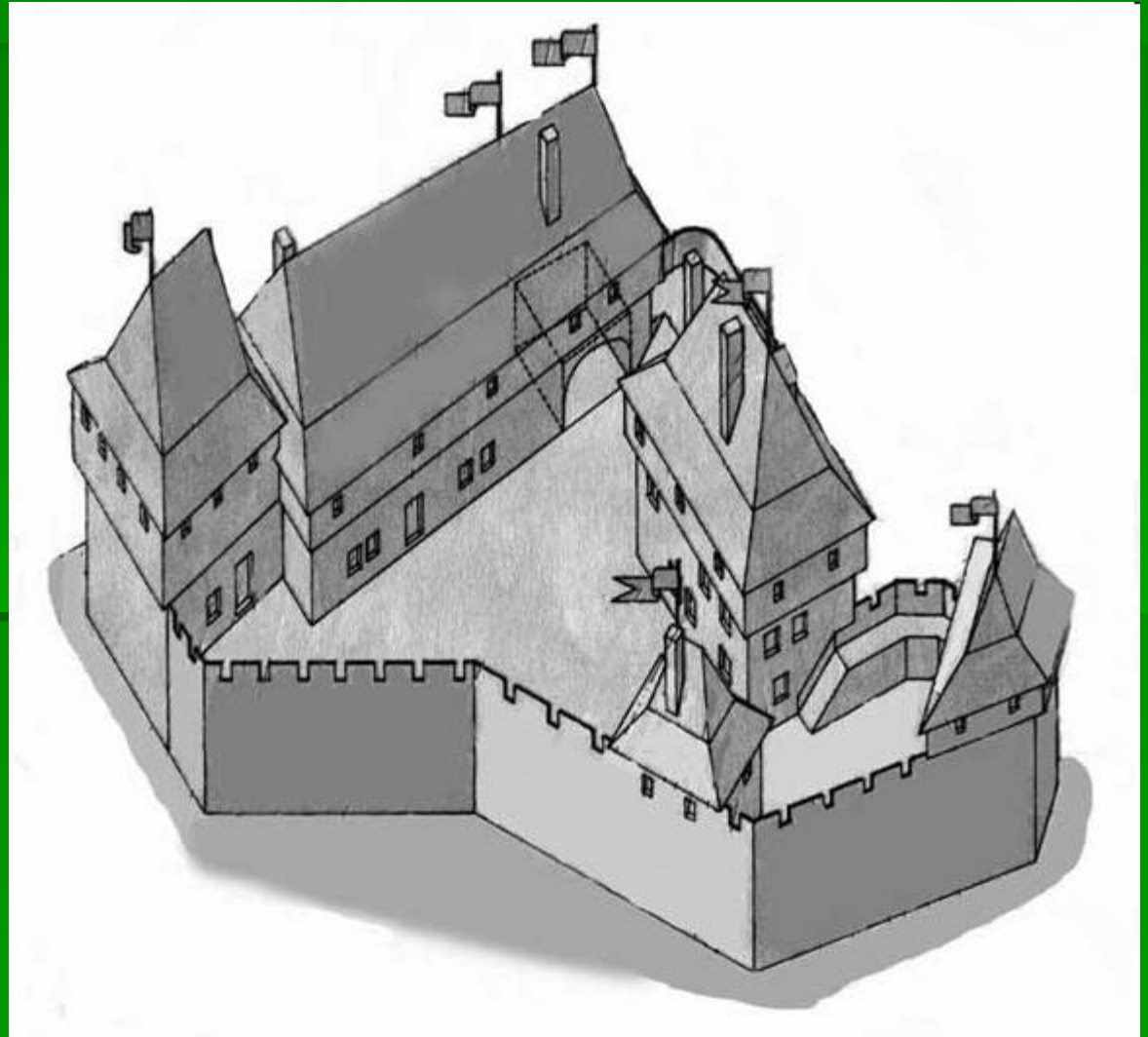
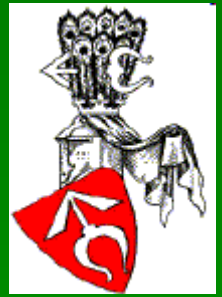

Kunětická hora

Diviš Bořek z Miletínka



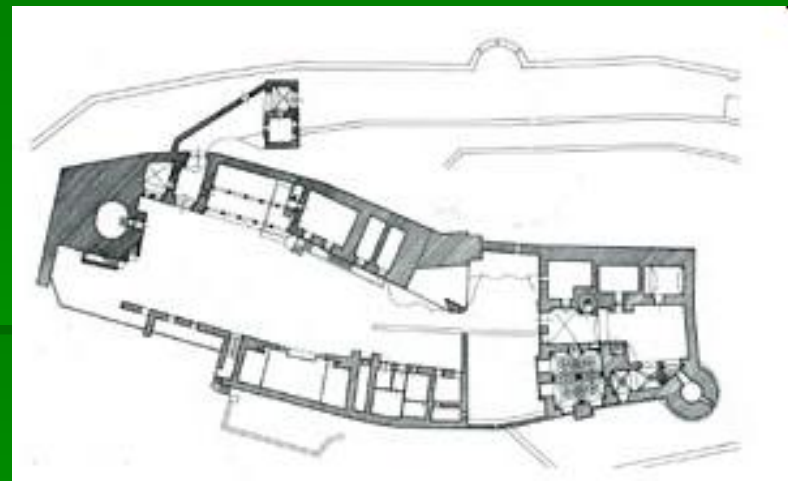
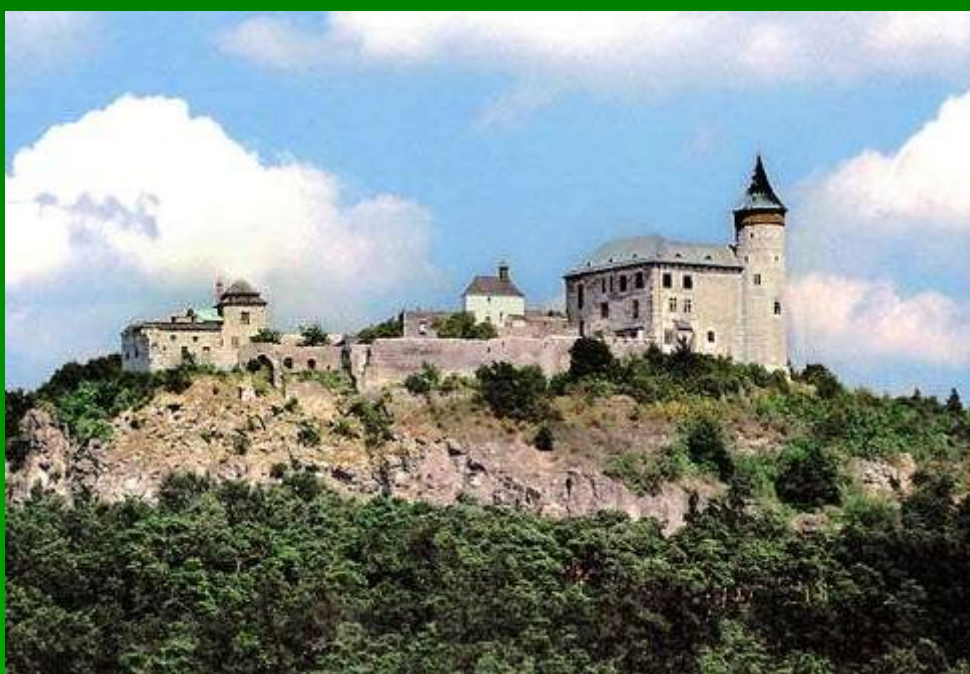

poezie.kvalitne.cz

© 2005 Oldřich DENK



Předsunutá opevnění Choustník – věž Kokot

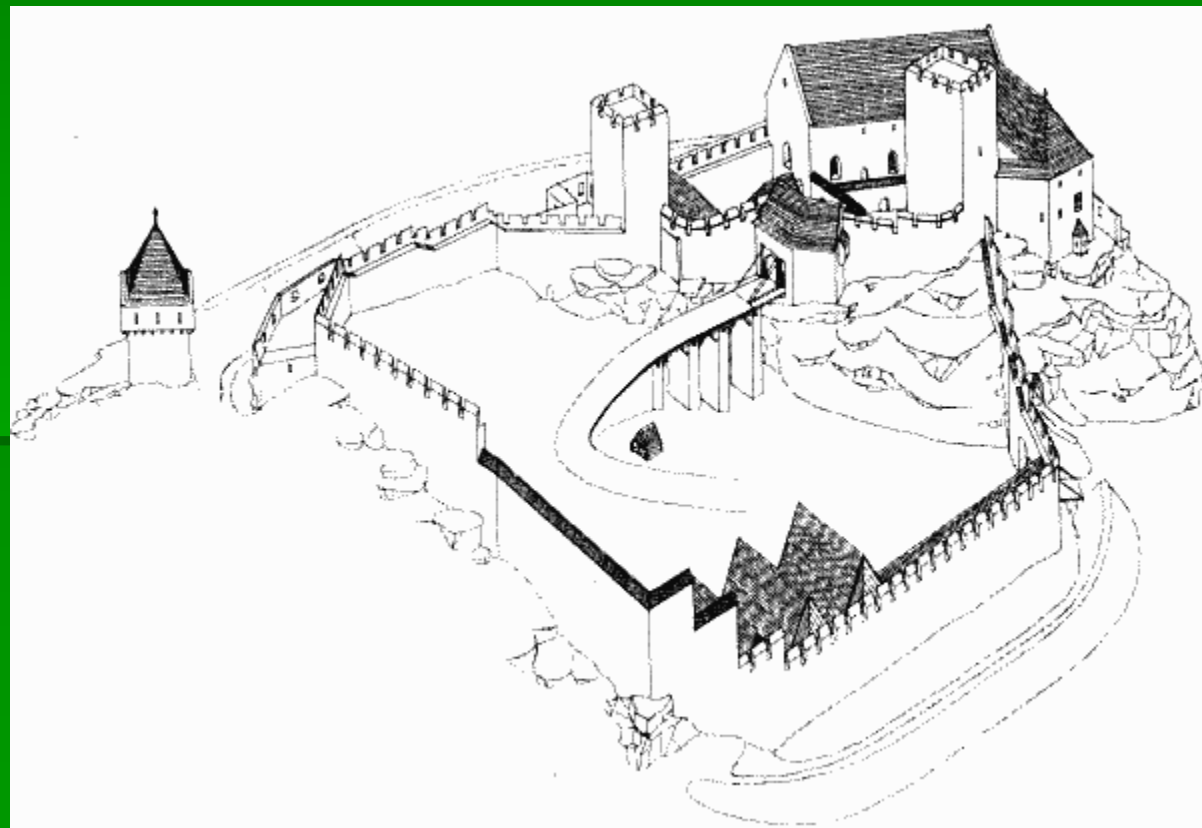

Český Šternberk



Český Šternberk

- předsunuté opevnění



Český Šternberk

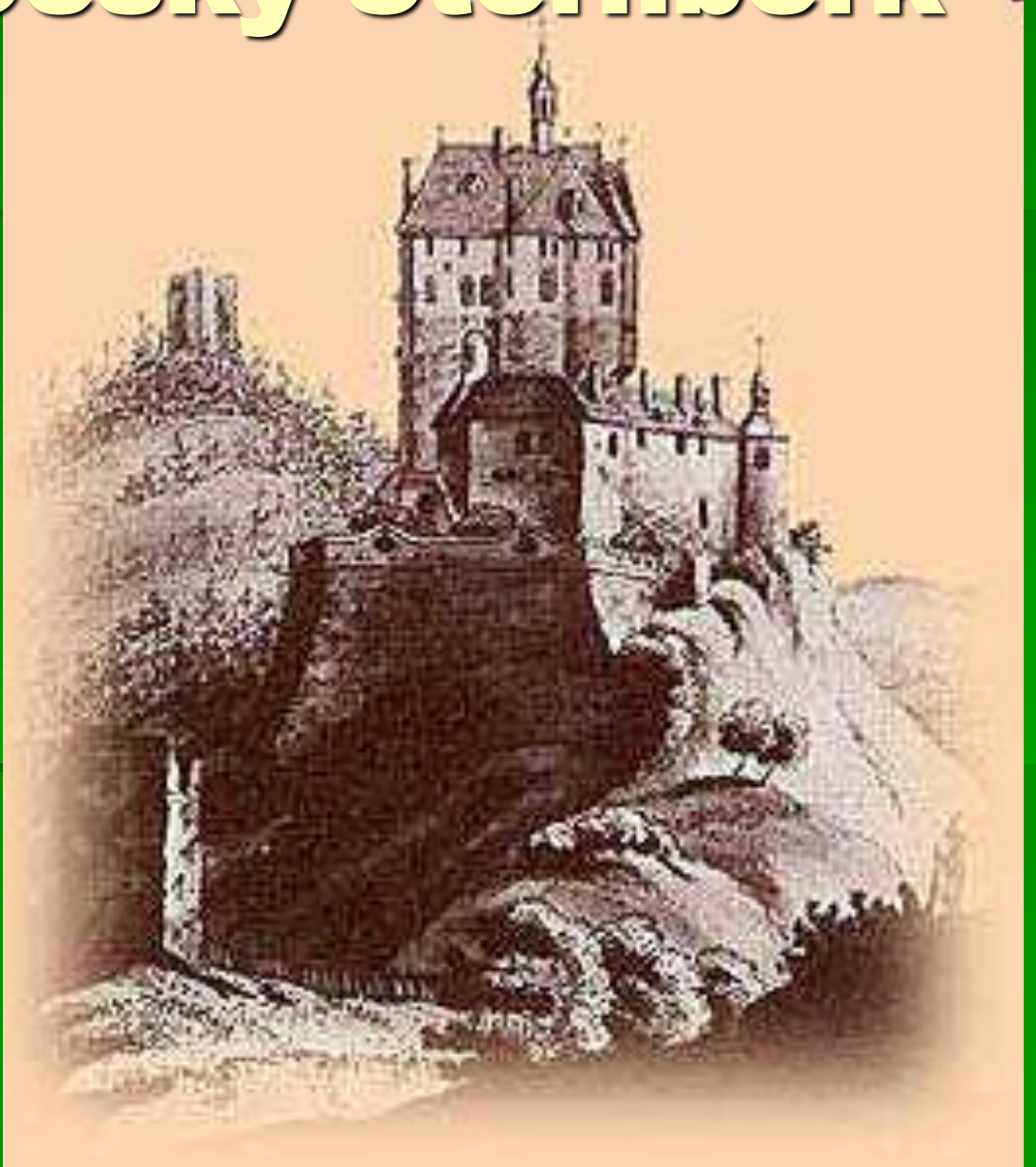
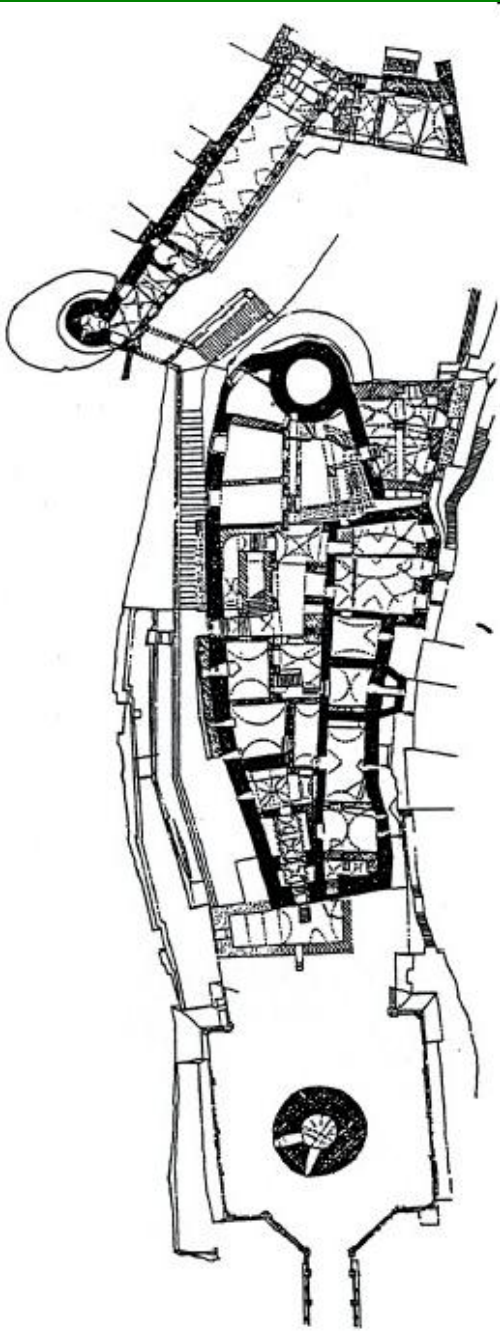

Vimperk

- opevněný komplex Kaplířů



1479

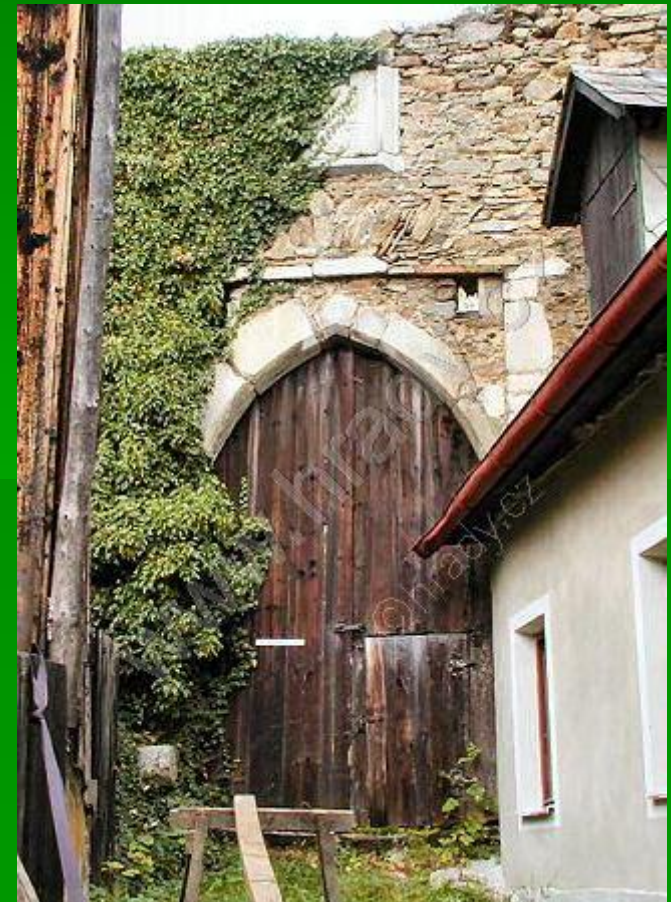
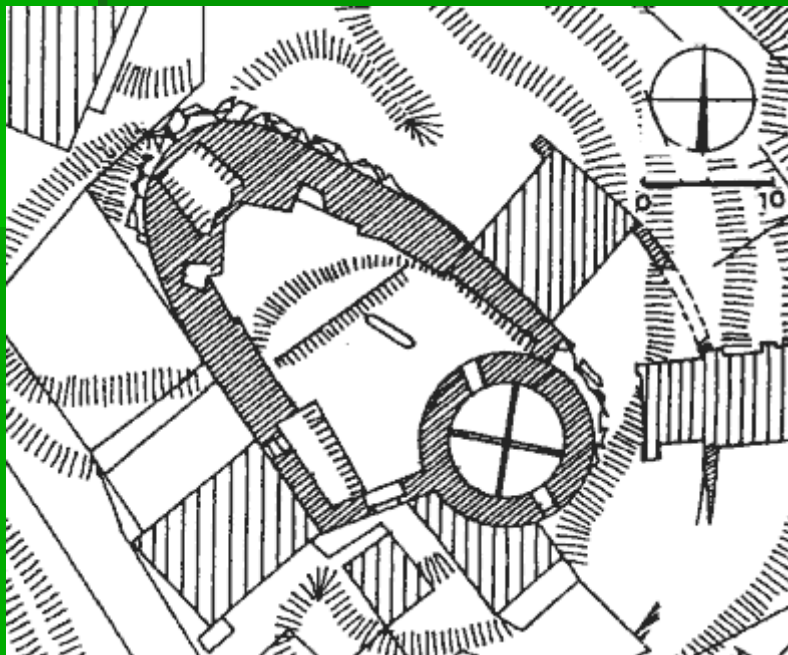



Haselburg

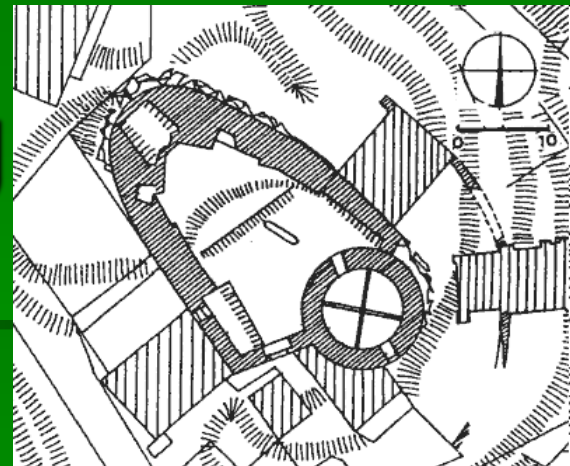

Mikulov Kozí Hrádek



Cornštejn Krajiřové z Krajku

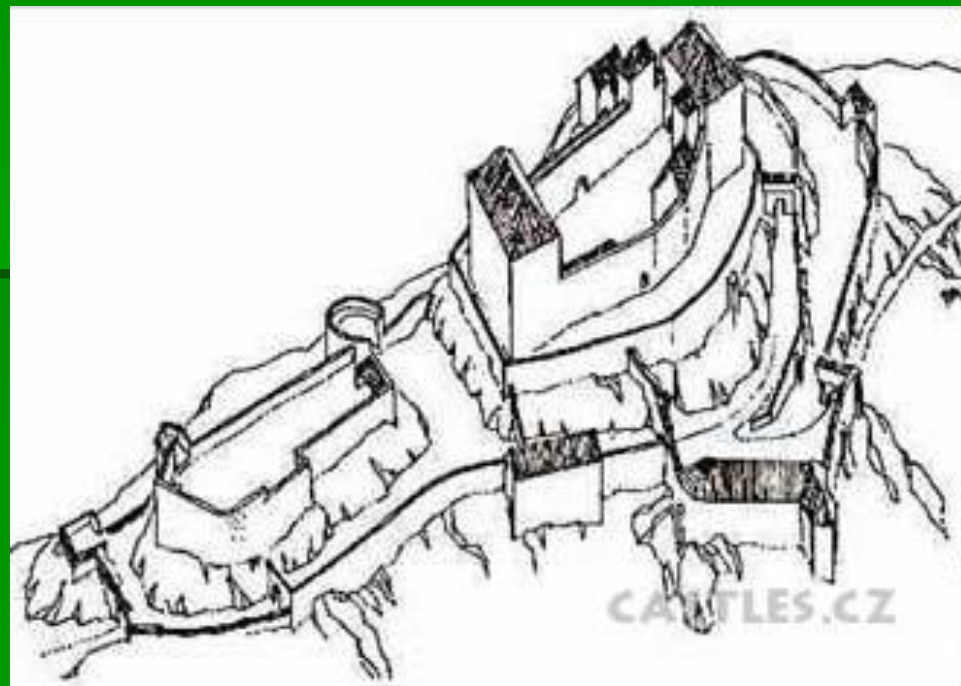

Jiří z Poděbrad 1458 - 1471





Litice



Litice



V popředí vývoje fortifikací

Racek II. Rýzmberský
z Janovic
Přibík Klenovský
z Klenové



x Klenového a x Janovic



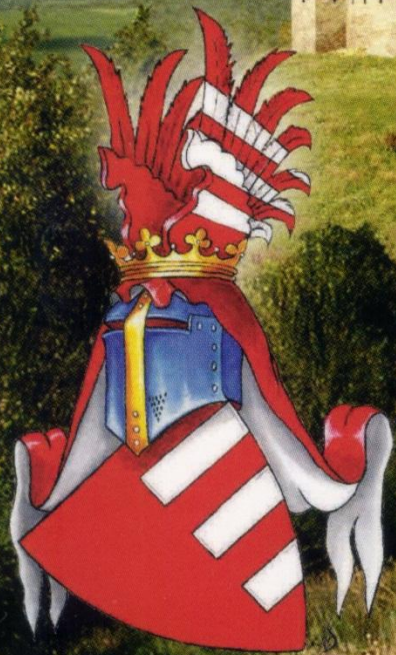

RÝZMBERK

Rýzmberk v polovině 15. století



Dva požáry hradu Rýzंबरka v r. 1448

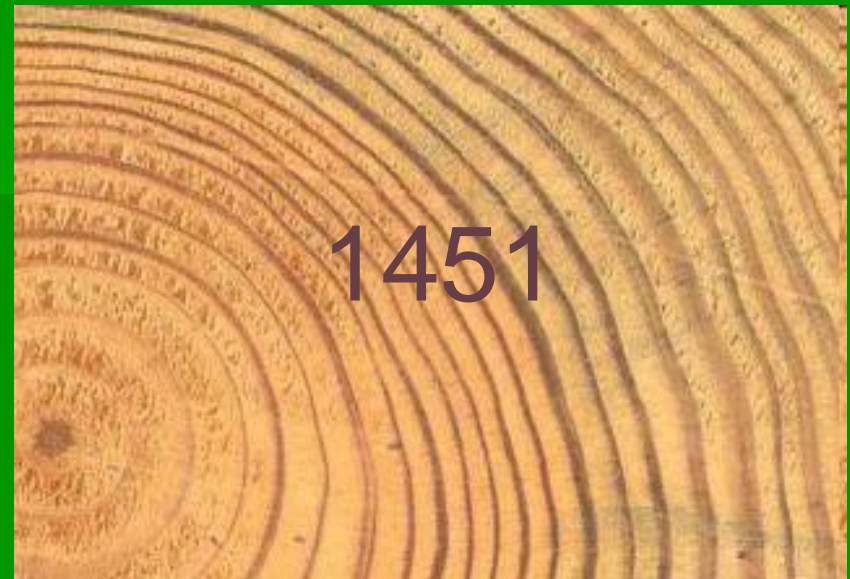

Export české válečné školy

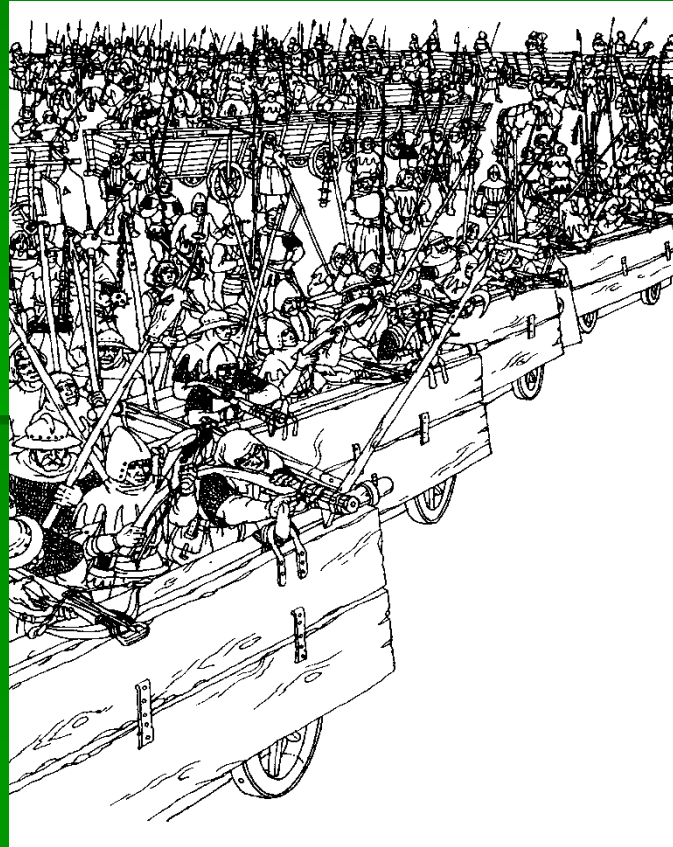

Državy Janovských a Pajreckých z Janovic roku 1468

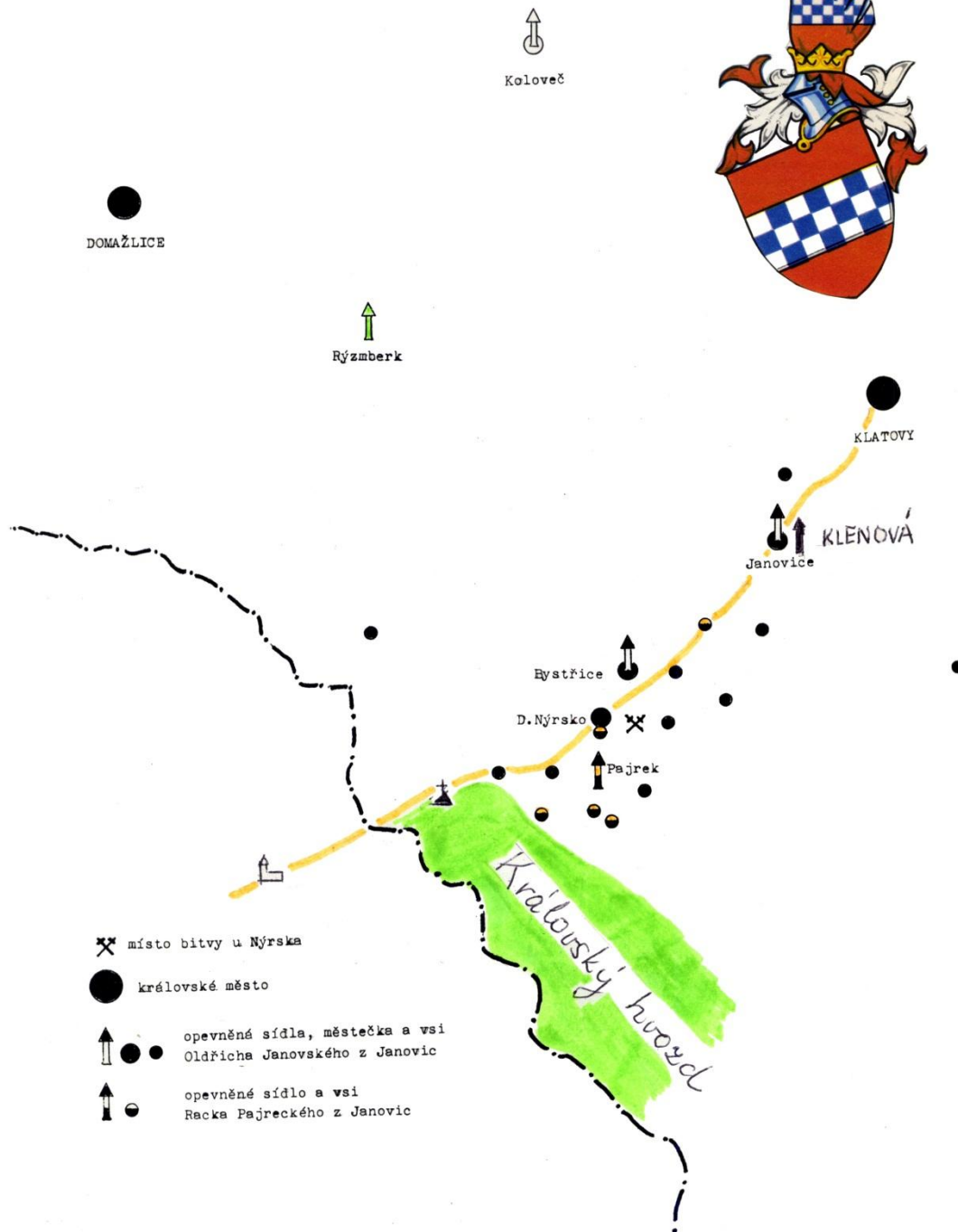

erb
Jiří Louda

Pohled z Rýzंबरka na Všerubský průsmyk





Klenová



Klenová opevnění z poloviny 15. století

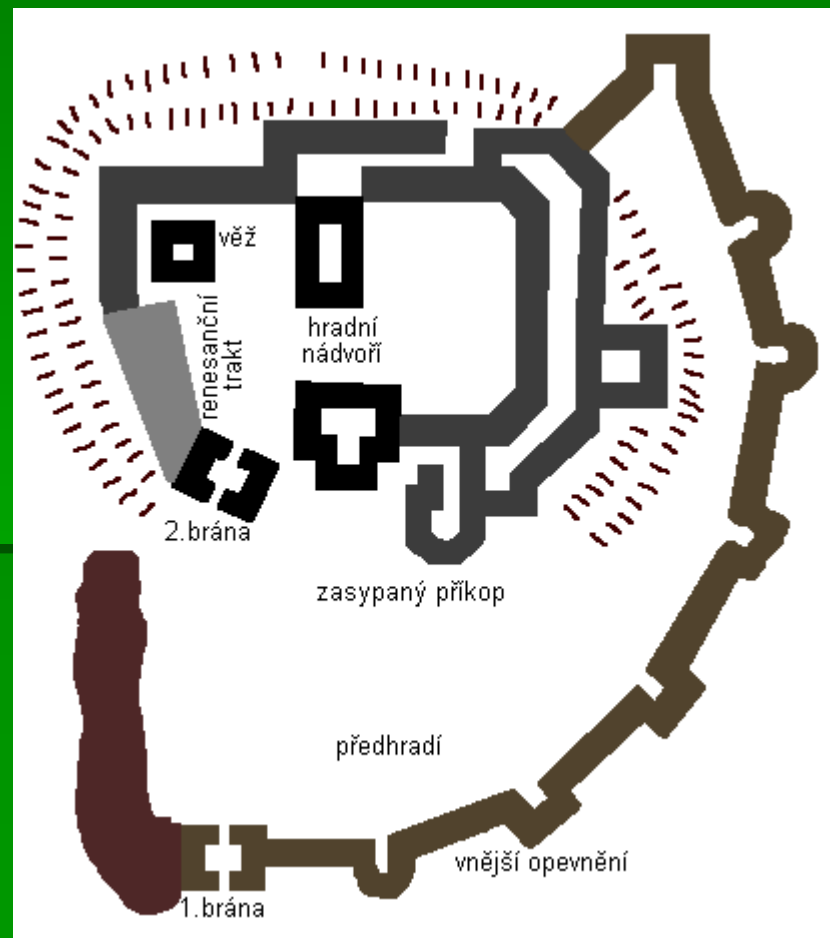

Přibík Klenovský
dobył 1426 město
Stříbro a r. 1427 ho
uhájil proti IV. křížové
výpravě



Tzv. Husitská
bašta – jediná,
která zbyla z
původních
sedmnácti bašt
městského
opevnění

Poběžovice

1470 Nový Ronšperk

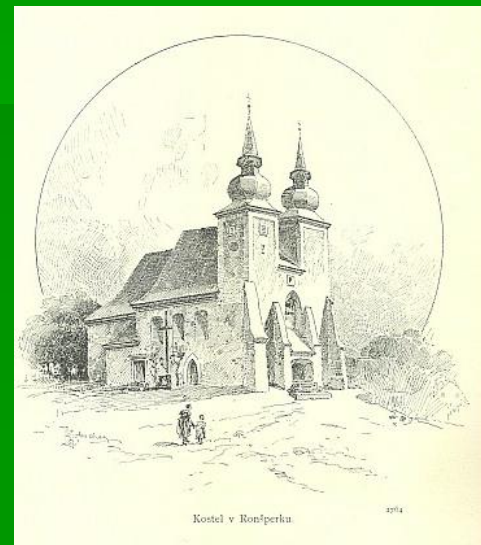
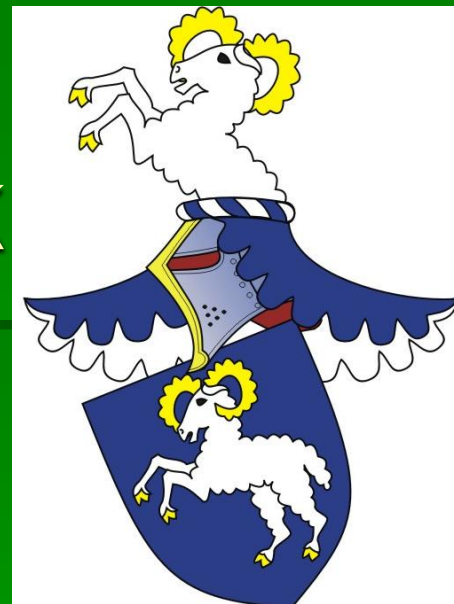



Horšovský Týn



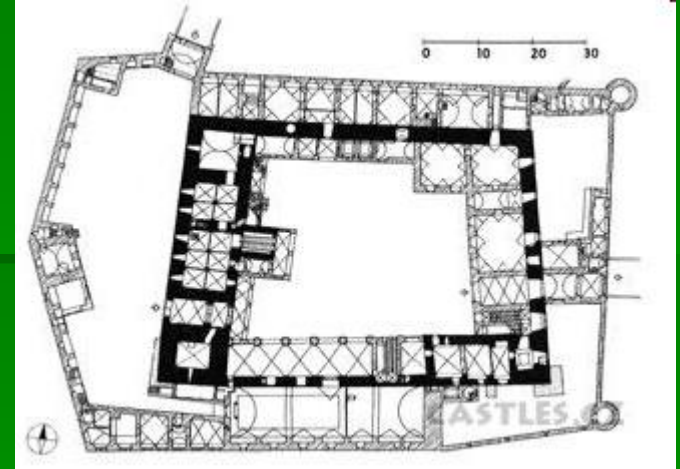

Hrad Držtka

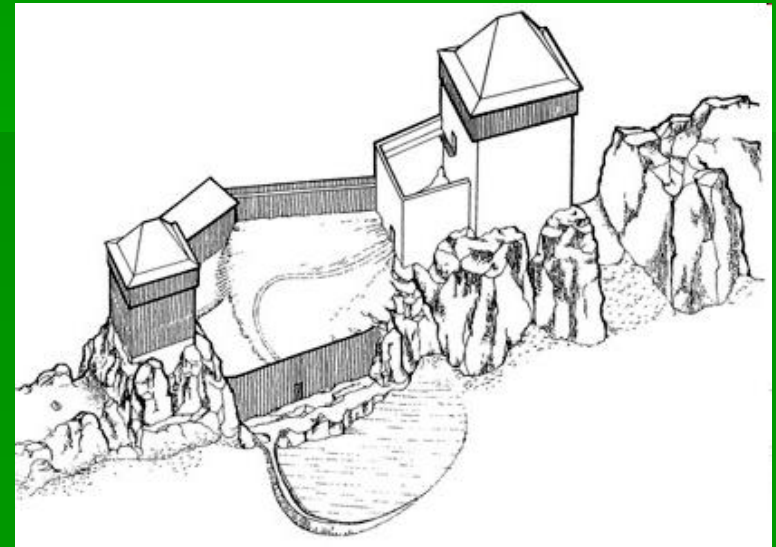

1864 – nizozemský rod Coudenhove-Kalergi

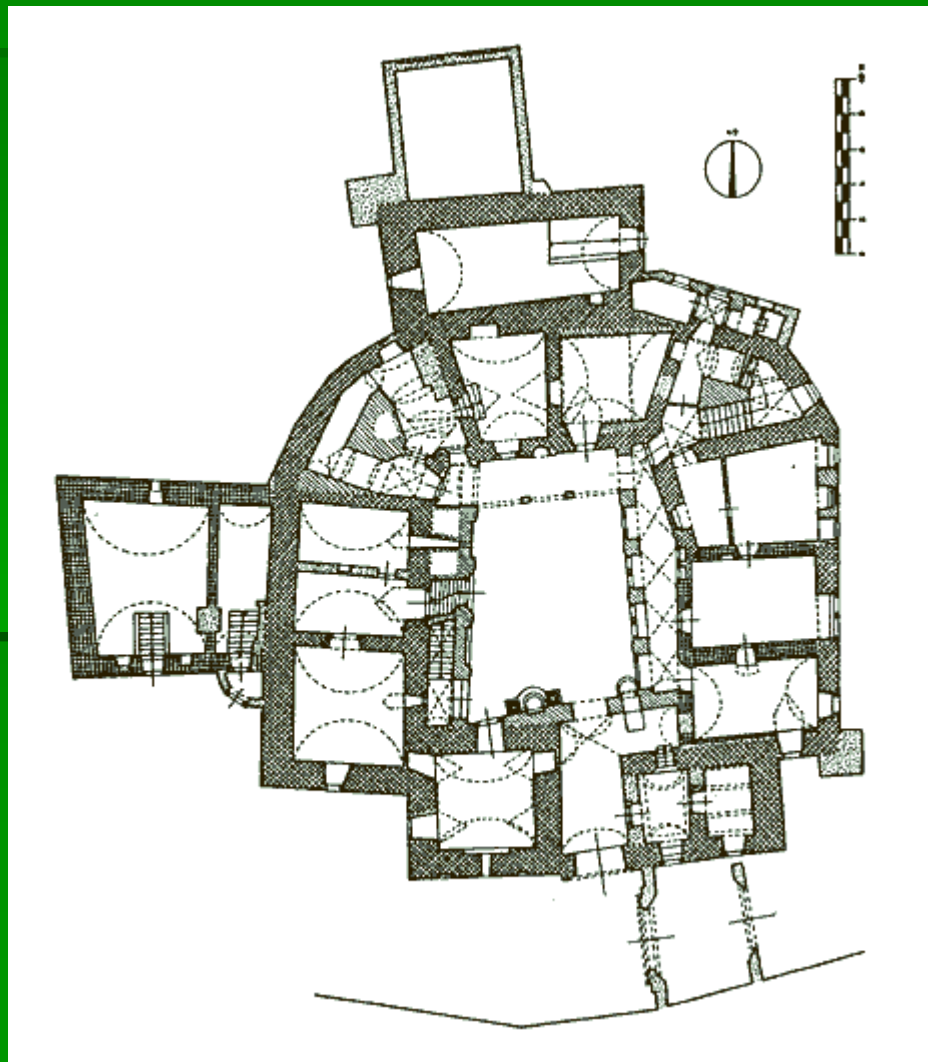
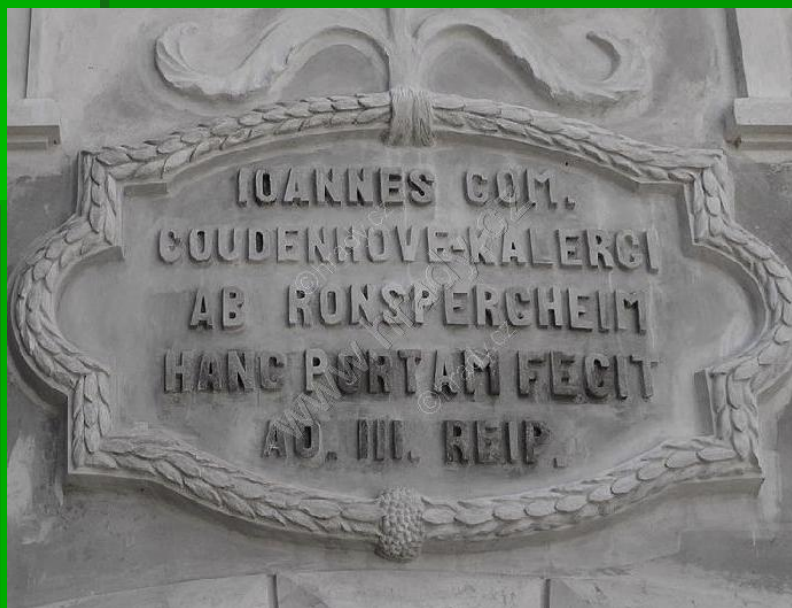

Dobrohost z Ronšperka 1459 - 1506

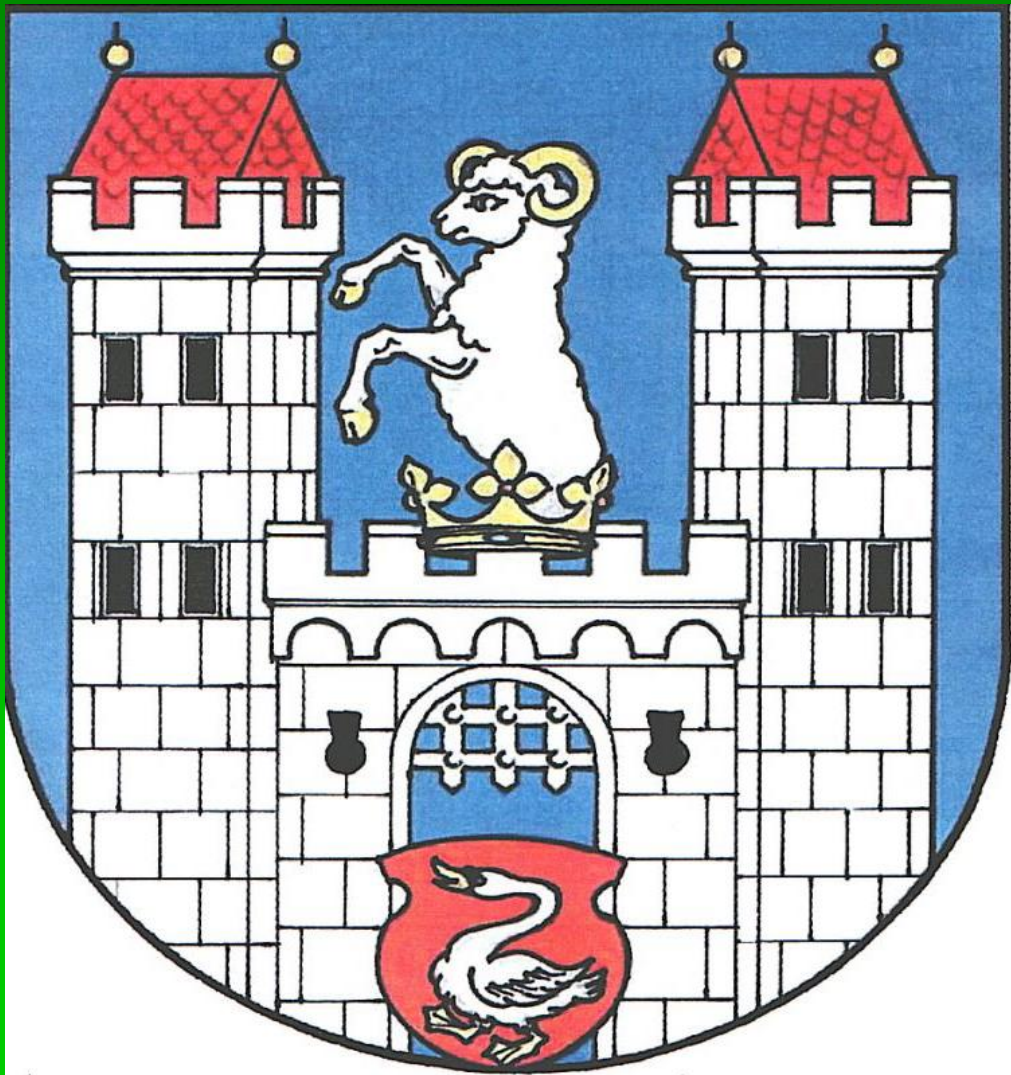

1502 povýšení
Poběžovic/Ronšperka
na město



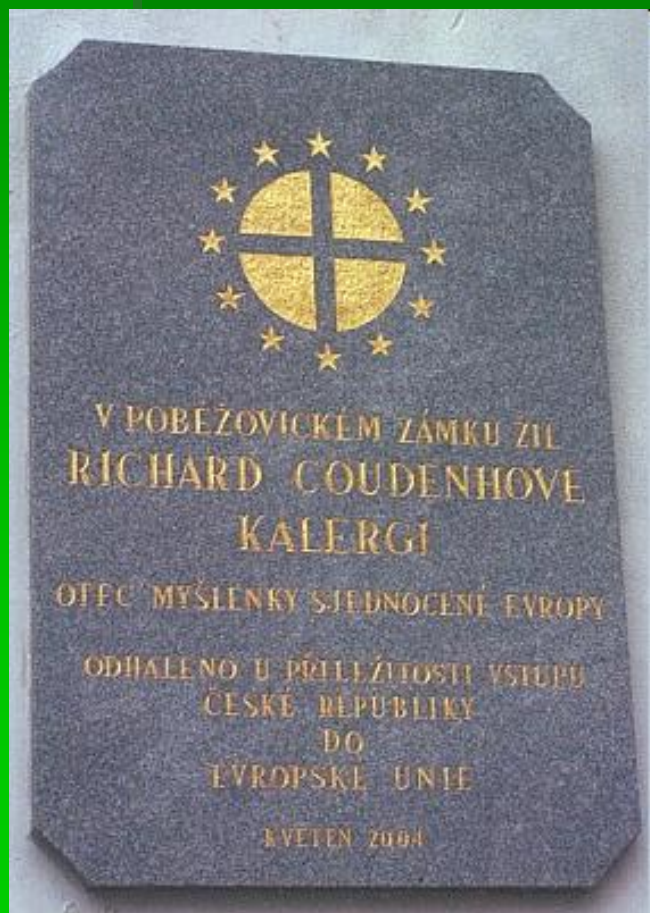
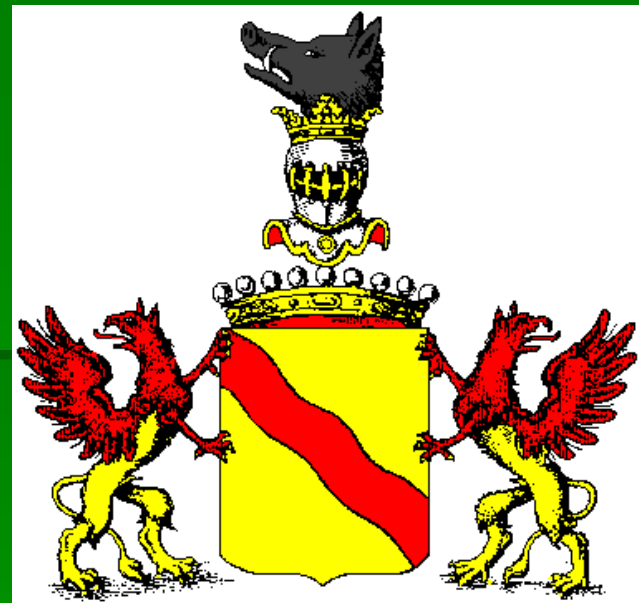

Romantická přestavba za Coudenhovů

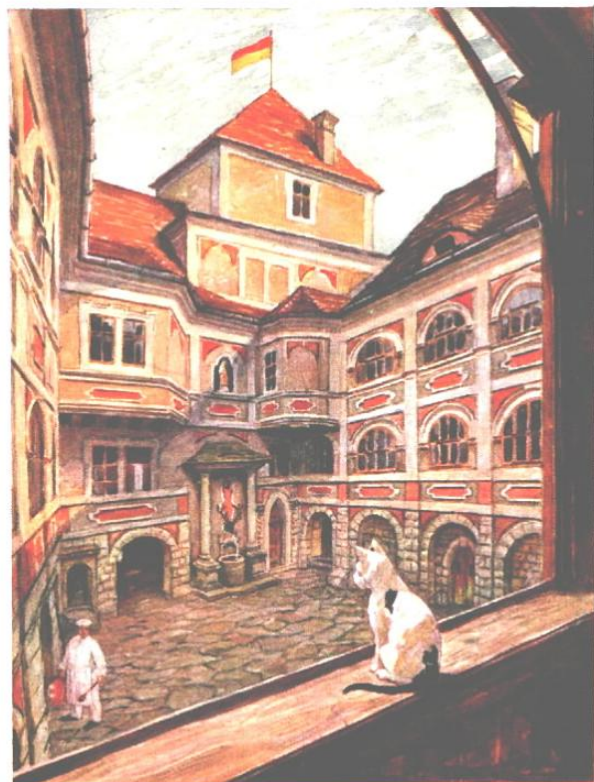

RONSPERG, Küchenhof.

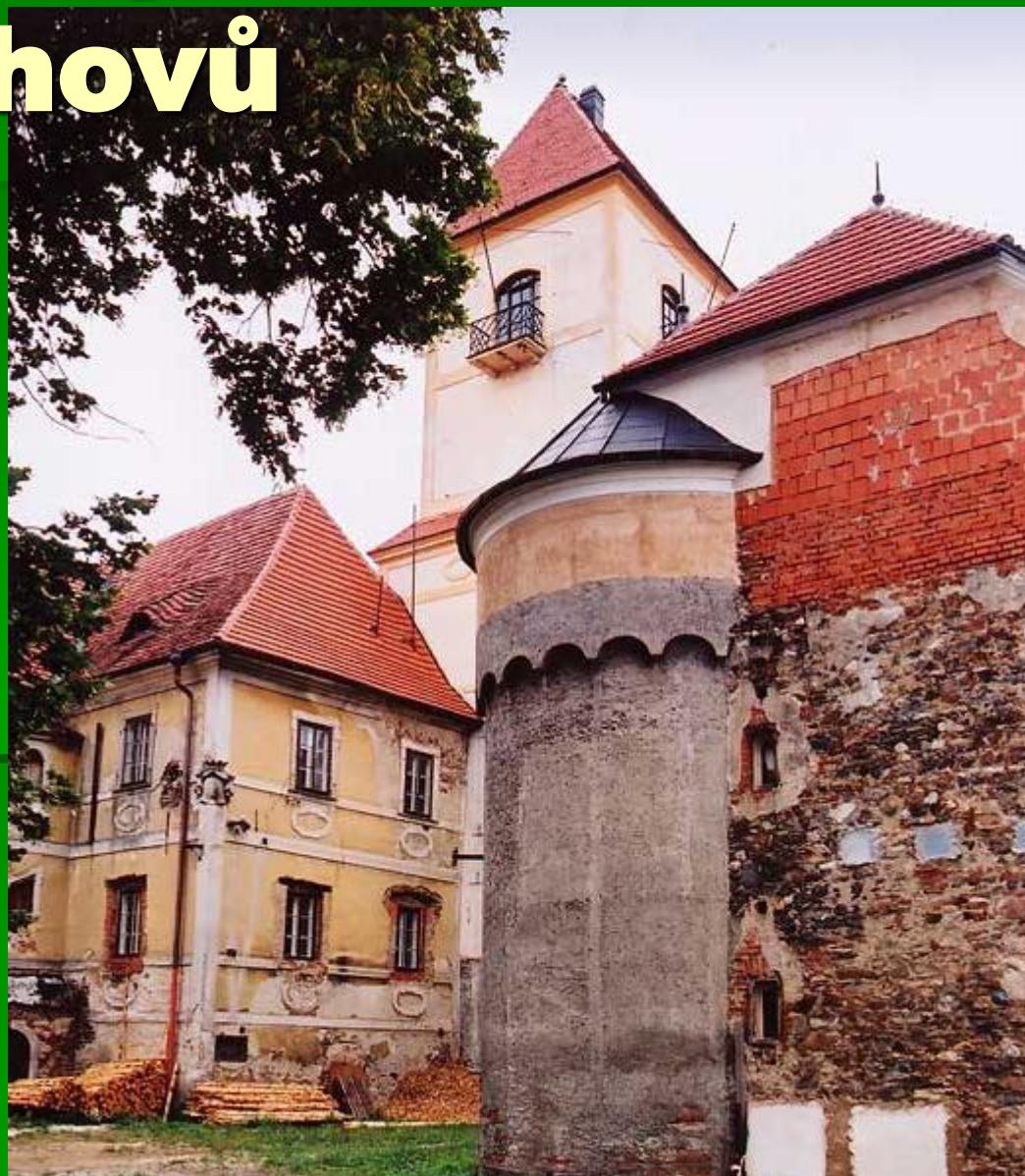

Don Baltazar Marradas na Ronšperku



Hraběnka Micuko

RICHARD N.
COUDENHOVE-KALERGI

PAN-EVROPA

Praha 1993

PAN
EVROPA
PRAHA

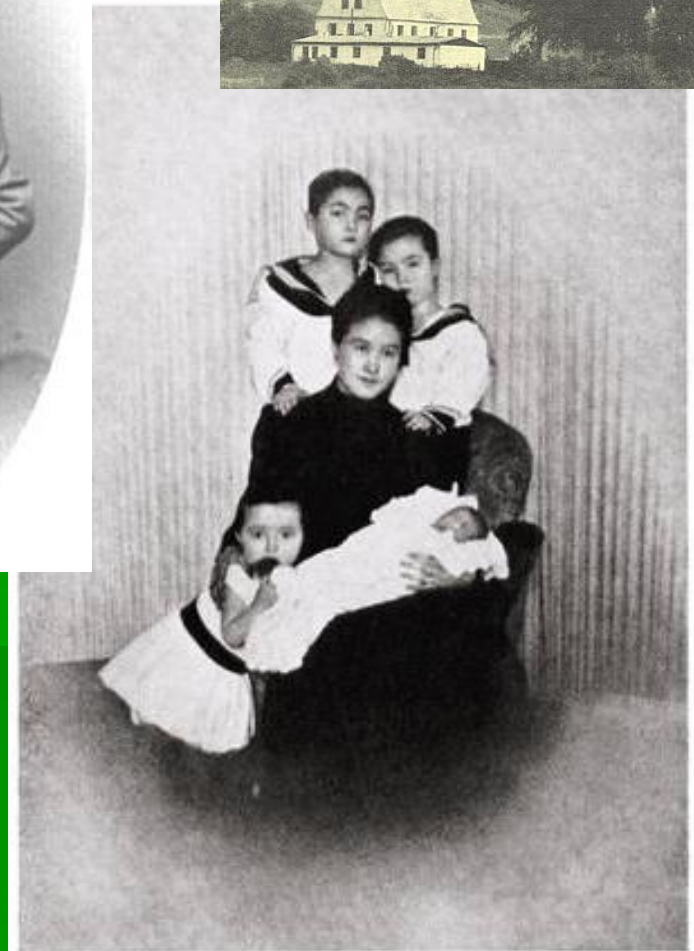

Gräfin Mitsu Coudenhove-Kalergi mit ihren ältesten Kindern
Hans, Richard, Gerolf und Elisabeth





Aleji na Ronšperku 2008